

University of Nebraska - Lincoln

DigitalCommons@University of Nebraska - Lincoln

---

The Handbook: Prevention and Control of Wildlife  
Damage

Wildlife Damage Management, Internet Center for

---

July 1994

## House Mice

Robert M. Timm

*University of California Hopland Research & Extension Center*

Follow this and additional works at: <http://digitalcommons.unl.edu/icwdmhandbook>



Part of the [Environmental Sciences Commons](#)

---

Timm, Robert M., "House Mice" (1994). *The Handbook: Prevention and Control of Wildlife Damage*. 4.  
<http://digitalcommons.unl.edu/icwdmhandbook/4>

This Article is brought to you for free and open access by the Wildlife Damage Management, Internet Center for at DigitalCommons@University of Nebraska - Lincoln. It has been accepted for inclusion in The Handbook: Prevention and Control of Wildlife Damage by an authorized administrator of DigitalCommons@University of Nebraska - Lincoln.

**Robert M. Timm**  
Superintendent and Extension  
Wildlife Specialist  
Hopland Research & Extension Center  
University of California  
Hopland, California 95449

# HOUSE MICE

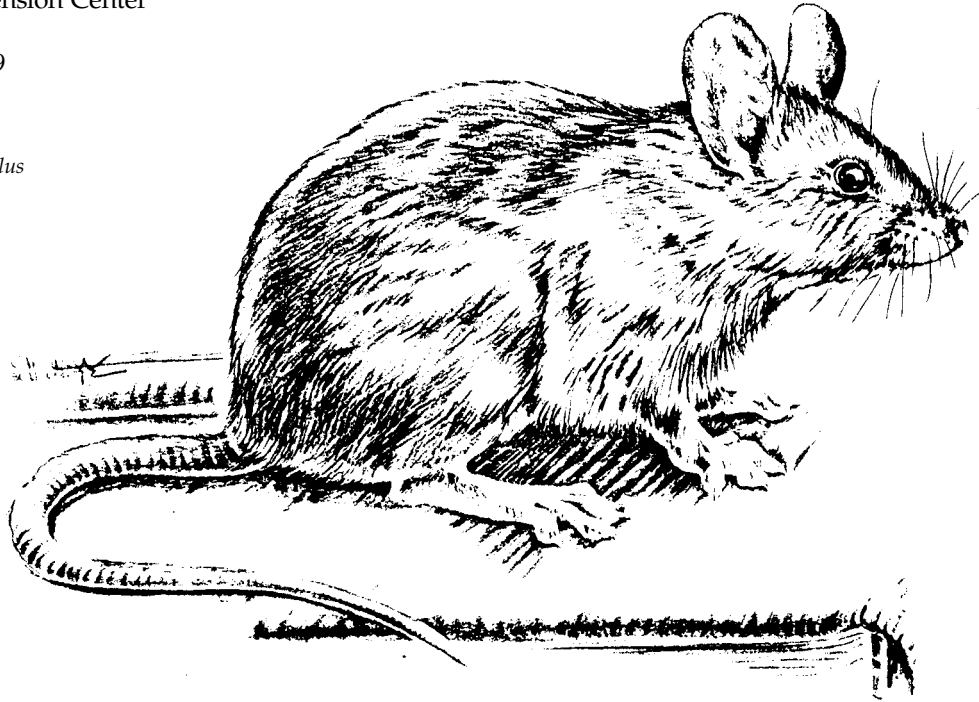

Fig. 1. House mouse, *Mus musculus*

---

## Damage Prevention and Control Methods

### Exclusion

Seal all openings larger than 1/4 inch (0.6 cm) wide.

### Habitat Modification

Good sanitation practices reduce sources of food, water, and shelter.

Store foodstuffs in rodent-proof structures or containers.

Control weeds and remove debris from around structures.

### Frightening

Ultrasonic devices have not been proven to control mice.

### Repellents

Ro-pel®

Moth flakes (naphthalene) not specifically registered, but may be of some value.

### Toxicants

Anticoagulant rodenticides (slow-acting chronic-type toxicants).  
Brodifacoum (Talon®).  
Bromadiolone (Maki®, Contrace®).  
Chlorophacinone (RoZol®).  
Diphacinone (Ditrac®).  
Pindone (Pival®, Pivalyn®).  
Warfarin (Final® and others).

Toxicants other than anticoagulants (may be acute or chronic poisons).  
Bromethalin (Assault®, Vengeance®).  
Cholecalciferol (Quintox®).  
Zinc phosphide (Ridall Zinc®, ZP®).

### Fumigants

Practical use is limited to structures, containers, and commodities; for use only by trained personnel.

### Trapping

Snap traps.

Live traps (Sherman-type, Ketch-All®, Tin Cat®, and others).

Glue boards.

### Other Methods

Predators: dogs and cats are of limited value in some situations.



---

## PREVENTION AND CONTROL OF WILDLIFE DAMAGE — 1994

Cooperative Extension Division  
Institute of Agriculture and Natural Resources  
University of Nebraska - Lincoln

United States Department of Agriculture  
Animal and Plant Health Inspection Service  
Animal Damage Control

Great Plains Agricultural Council  
Wildlife Committee

## Identification

The house mouse (*Mus musculus*, Fig. 1) is a small, slender rodent that has a slightly pointed nose; small, black, somewhat protruding eyes; large, sparsely haired ears; and a nearly hairless tail with obvious scale rings. House mice are considered among the most troublesome and economically important rodents in the United States.

Adult house mice weigh about 2/5 to 4/5 ounce (11 to 22 grams). They are generally grayish brown with a gray or buff belly. Similar mice include the white-footed mice and jumping mice (which have a white belly), and harvest mice (which have grooved upper incisor teeth). For more details on species identification, see a field guide such as that by Burt and Grossenheider (1976).

Native to central Asia, this species arrived in North America with settlers from Europe and from other points of origin. A very adaptable species, the house mouse often lives in close association with humans and therefore is termed one of the "commensal" rodents along with Norway and roof rats. House mice are much more common in residences and commercial structures than are rats. Brooks (1973) regards them to be the most common mammal in cities, next to humans.

## Range

Following their arrival on colonists' ships, house mice spread across North America and are now found in every state, including coastal areas of Alaska, and in the southern parts of Canada.

## Habitat

House mice live in and around homes, farms, commercial establishments, and in open fields and agricultural lands. At times they may be found living far from human settlements, particularly where climates are moderate. The onset of cold weather each fall in temperate regions may cause mice to

move into structures in search of shelter and food.

## Food Habits

House mice eat many types of food but prefer seeds and grain. They are not hesitant to eat new foods and are considered "nibblers," sampling many kinds of items that may exist in their environment. Foods high in fat, protein, or sugar may be preferred even when grain and seed are present. Such items include bacon, chocolate candies, butter, and nutmeats.

Unlike Norway and roof rats, house mice can survive with little or no free water, although they readily drink water when it is available. They obtain their water from the food they eat. An absence of liquid water or food of adequate moisture content in their environment may reduce their breeding potential.

## General Biology, Reproduction, and Behavior

House mice are mainly nocturnal, although at some locations considerable daytime activity may be seen. Seeing mice during daylight hours does not necessarily mean that a high population is present, although this is usually true for rats.

Mice have poor eyesight, relying on their hearing and their excellent senses of smell, taste, and touch. They are considered color-blind; therefore, for safety reasons, baits can be dyed distinctive colors without causing avoidance by mice, as long as the dye does not have an objectionable taste or odor.

House mice may burrow into the ground in fields or around structures when other shelter is not readily available. Nesting may occur in the ground or in any sheltered location. Nests are constructed of shredded fibrous materials such as paper, burlap, or other similar items, and generally have the appearance of a "ball" of material

loosely woven together. They are usually 4 to 6 inches (10.2 to 15.2 cm) in diameter.

Litters of 5 or 6 young are born 19 to 21 days after mating, although females that conceive while still nursing may have a slightly longer gestation period. Mice are born hairless and with their eyes closed. They grow rapidly, and after 2 weeks they are covered with hair and their eyes and ears are open. They begin to make short excursions from the nest and eat solid food at 3 weeks. Weaning soon follows, and mice are sexually mature at 6 to 10 weeks of age.

Mice may breed year-round, but when living outdoors, they breed mostly in spring and fall. A female may have 5 to 10 litters per year. Mouse populations can therefore grow rapidly under good conditions, although breeding and survival of young decline markedly when population densities become high.

House mice have physical capabilities that enable them to gain entry to structures by gnawing, climbing, jumping, and swimming. For more detailed information on their physical abilities and the resulting need to design rodent-proof structures, see the chapter **Rodent-Proof Construction and Exclusion Methods**.

Studies indicate that during its daily activities, a mouse normally travels an area averaging 10 to 30 feet (3 m to 9 m) in diameter. Mice seldom travel farther than this to obtain food or water. Because of their limited movement and feeding behavior, both of which differ from those of commensal rats, they are much more difficult to control in some situations.

Mice constantly explore and learn about their environment, memorizing the locations of pathways, obstacles, food and water, shelter, and other elements in their domain. They quickly detect new objects in their environment but, unlike rats, do not fear them. Thus, they will almost immediately enter bait stations and sample new foods (baits). The degree to which mice consume a particular food

depends on the flavor of the food in addition to its physiological effect. Mice may reject baits simply because they do not taste as good as other available foods.

If the bait contains poison or some other substance that produces an ill effect (but not death) within a few hours, the bait will often become associated with the illness. Bait shyness can persist for weeks or months and may be transferred to nontoxic foods of similar types. Prebaiting, that is, training mice to feed repeatedly on nontoxic bait for a period of days prior to applying the toxicant in the bait, will largely prevent sublethal doses and thus bait shyness. It will also reduce the number of mice left to be bait shy. Prebaiting is especially recommended with zinc phosphide baits. All of the other toxic baits currently registered for house mice are chronic or slow-acting. Because of this slow action, the mice's subsequent illness is not associated with the bait even if a sublethal dose is consumed; thus, bait shyness does not usually occur. These baits, in effect, serve as their own prebait.

## Damage and Damage Identification

When house mice live in or around structures, they almost always cause some degree of economic damage. In homes and commercial buildings, they may feed on various stored food items or pet foods. In addition, they usually contaminate foodstuffs with their urine, droppings, and hair. On farms, they may cause damage to feed storage structures and feed transporting equipment. A single mouse eats only about 3 grams of food per day (8 pounds [3.6 kg] per year) but destroys considerably more food than it consumes because of its habit of nibbling on many foods and discarding partially eaten items.

House mice living in fields may dig up and feed on newly planted grain, or may cause some damage to crops before harvest. But losses in stored foods are considerably greater. Mice commonly damage containers and

packaging materials in warehouses where food and feeds are stored. Much of this loss is due to contamination with droppings and urine, making food unfit for human consumption.

House mice cause structural damage to buildings by their gnawing and nest-building activities. In livestock confinement facilities and similar structures, they may quickly cause extensive damage to insulation inside walls and attics. Such damage also occurs in homes, apartments, offices, and commercial buildings but usually at a slower rate because mouse populations in such structures are smaller. House mice often make homes in large electrical appliances, and here they may chew up wiring as well as insulation, resulting in short circuits which create fire hazards or other malfunctions that are expensive to repair. Mice may also damage stored items in attics, basements, garages, or museums. Damaged family heirlooms, paintings, books, documents, and other such items may be impossible to replace.

Among the diseases mice or their parasites may transmit to humans are salmonellosis (food poisoning), rickettsialpox, and lymphocytic choriomeningitis. Mice may also carry leptospirosis, ratbite fever, tapeworms, and organisms that can cause ringworm (a

fungal skin disease) in humans. They have also been found to act as reservoirs or transmitters of diseases of veterinary importance, such as swine dysentery, a serious bacterial disease of swine often called "bloody scours."

### Mouse Sign

The presence of house mice can be determined by a number of signs described below:

**Droppings** may be found along runways, in feeding areas, and near shelter. Differentiating between mouse droppings and those of certain insects may be difficult. Mouse droppings are about 1/4 inch (0.6 cm) long, whereas those of cockroaches are usually 1/8 to 1/4 inch (0.3 to 0.6 cm) long and under a magnifying glass show distinct longitudinal ridges and squared-off ends. In comparison, droppings of bats contain insect fragments and are more easily crushed between the fingers.

**Tracks**, including footprints or tail marks, may be seen on dusty surfaces or in mud (Fig. 2). A tracking patch made of flour, rolled smooth with a cylindrical object, can be placed in pathways overnight to determine if rodents are present.

**Urine**, both wet and dry, will fluoresce under ultraviolet light, although so will some other materials. Urine

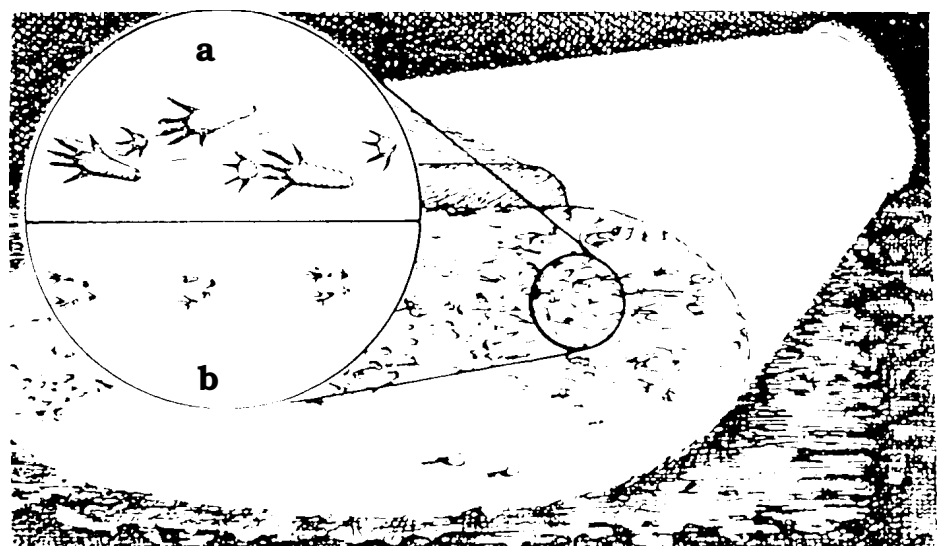
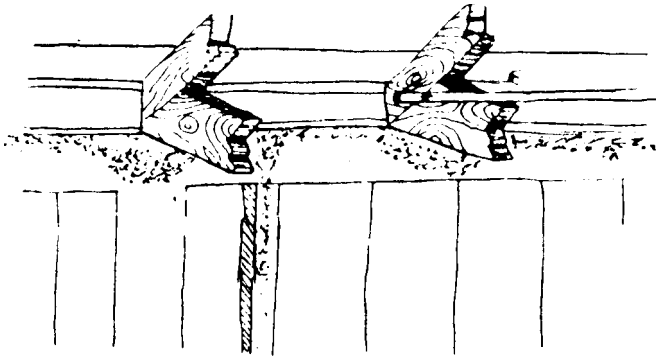

Fig. 2. Tracks left in dust by (a) Norway rat and (b) house mouse.



## Legal Status

House mice are not protected by law. They may be controlled using any pesticide registered by federal or state authorities for this purpose, or they may be controlled by use of mechanical methods such as traps.

## Damage Prevention and Control Methods

Effective prevention and control of house mouse damage involves three aspects: rodent-proof construction, sanitation, and population reduction by means of traps, toxicants, or fumigants. The first two are useful as preventive measures, but when a house mouse infestation already exists, some form of population reduction is almost always necessary. A flow chart outlining steps in controlling house mice is found in figure 4.

Control of house mice differs in important ways from the control of Norway or roof rats. Mice are smaller and therefore can enter narrower openings, making rodent-proofing more difficult. They have limited areas of movement (home range) and require little or no free water. While having a reproductive capability that is higher than that of rats, house mice are usually less sensitive (often far less sensitive) to many rodenticides. Persons who do not take these differences into account when attempting house mouse control may expect poor results.

After rats are controlled at a given location, house mice may increase in numbers by moving in from elsewhere or by reproduction. This may be expected because habitats suitable for rats are usually even more suitable for mice. One should anticipate that following rat control, the potential for house mouse problems may increase, and control measures should be taken before mouse numbers reach high levels.

Fig. 3. Rub marks along beams, rafters, or other travel routes give evidence of rodent activity. Mouse rub marks can be distinguished from those of rats by their smaller size.

stains may occur along travelways or in feeding areas.

**Smudge marks** (rub marks) may occur on beams, rafters, pipes, walls, and other parts of structures. They are the result of oil and dirt rubbing off mice's fur along frequently traveled routes (Fig. 3). They may be less apparent than rub marks left by rats.

**Gnawing** may be visible on doors, ledges, in corners, in wall material, on stored materials, or on other surfaces wherever mice are present. Fresh accumulations of wood shavings, insulation, and other gnawed material indicate active infestations. Size of entry holes (often 1 1/2 inches [3.8 cm] in diameter or less for mice, 2 inches [5 cm] or larger for rat) or tooth marks can be used to distinguish rat gnawing from mouse gnawing. Mice keep their paired incisor teeth, which grow continuously, worn down by gnawing on hard surfaces and by working them against each other.

**Sounds** such as gnawing, climbing in walls, running across the upper surface of ceilings, and squeaks are common where mice are present.

**Visual sightings** of mice may be possible during daylight hours, and mice also can be seen after dark with the aid of a flashlight or spotlight.

**Nests** frequently are found when cleaning garages, closets, attics, basements, and outbuildings where mice are present. They consist of fine, shredded fibrous materials.

**Odors** may indicate the presence of house mice. A characteristic musky odor is a positive indication that house mice are present, and this odor can be used to differentiate their presence from that of rats.

### Estimating Mouse Numbers

Mouse sign and visual sightings are of limited value in accurately estimating mouse numbers, but they are the simplest and often the only practical method available. Search premises thoroughly when looking for mice. In structures, searches should include attics, basements, around foundations, crawl spaces, and behind and under stored materials.

One method to detect the presence of mice is to make nontoxic tracking-dust patches of flour or talc at 20- to 30-foot (6- to 9-m) intervals throughout a structure. The number of patches showing tracks after 24 hours, and the abundance of tracks in each patch, indicate the size of the population. Because house mice, unlike rats, do not travel far from their nests or shelter, the percentage of patches showing tracks is a good indicator of the relative size and distribution of the mouse population.

Snap trapping is also an excellent way to determine the presence of mice. A relative index of mouse abundance can be calculated from the number of mice trapped for a certain number of traps set during 1 or more nights (for example, 35 mice caught per 100 trap nights).

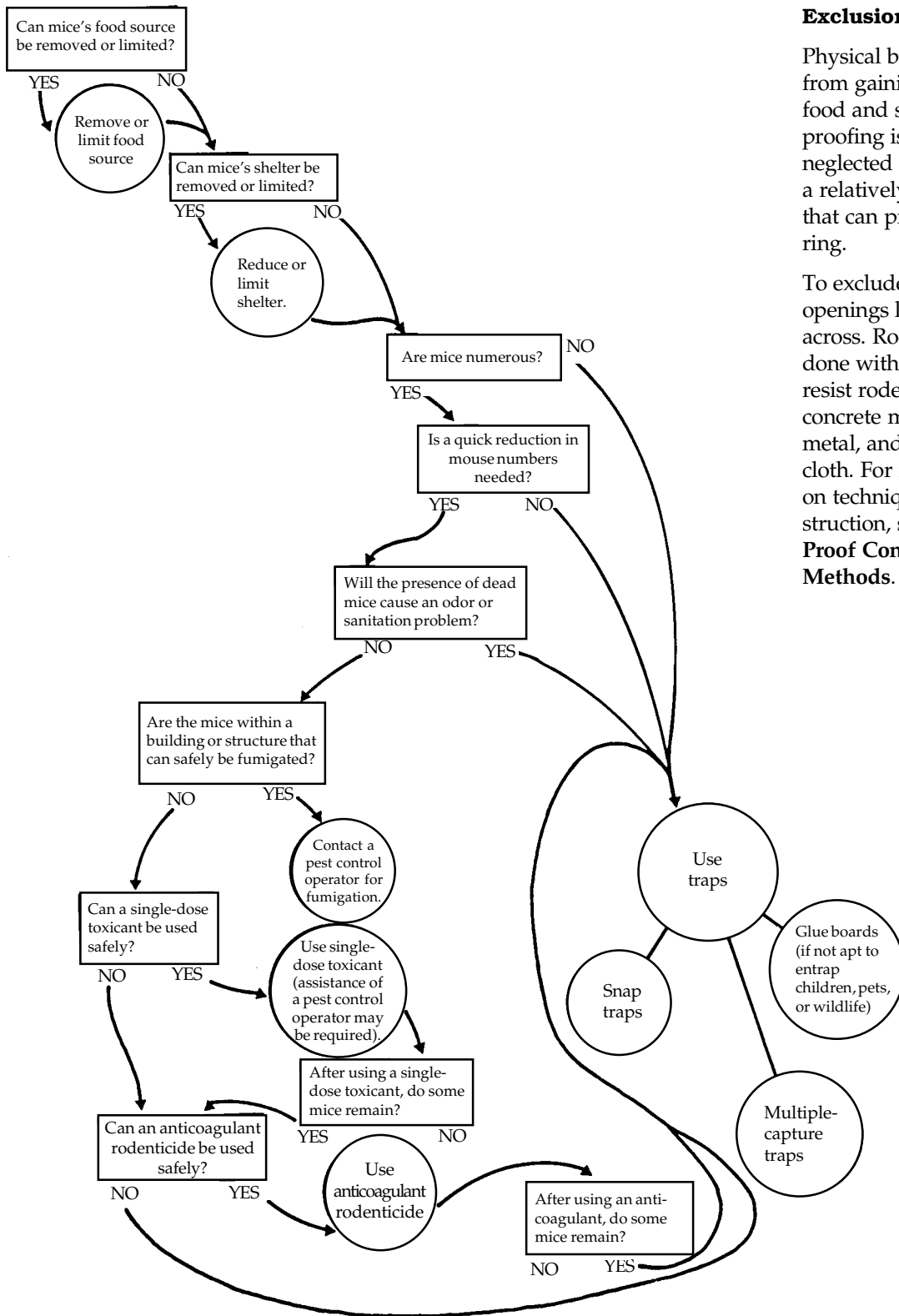

**Exclusion**

Physical barriers can prevent mice from gaining entry to structures where food and shelter are available. Rodent-proofing is an important and often neglected aspect of rodent control. It is a relatively permanent form of control that can prevent damage from occurring.

To exclude mice, seal all holes and openings larger than 1/4 inch (0.6 cm) across. Rodent-proofing should be done with heavy materials that will resist rodent gnawing. These include concrete mortar, galvanized sheet metal, and heavy-gauge hardware cloth. For more detailed information on techniques of mouse-proof construction, see the chapter **Rodent-Proof Construction and Exclusion Methods**.

Fig. 4. A flow chart of steps in controlling house mouse populations. Additional factors, such as the cost of particular control methods, must be taken into account when planning a control program (see text).

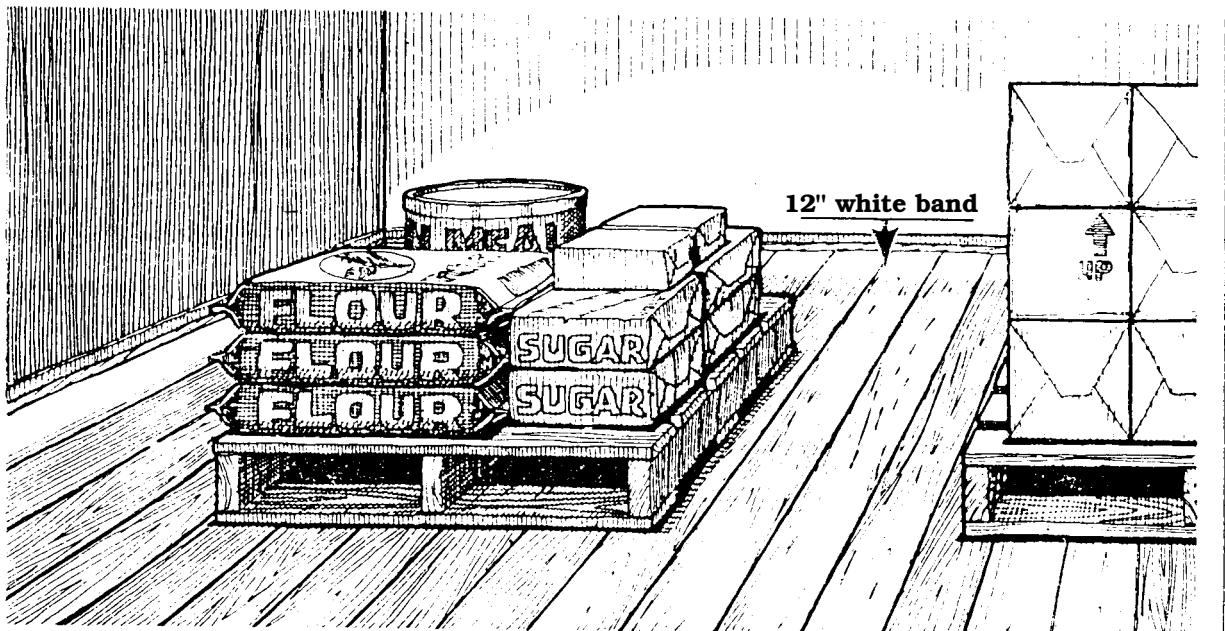

Fig. 5. A 12-inch (30.5-cm) white painted band makes inspection for rodent sign easier and reminds personnel not to store commodities too close to walls.

### Habitat Modification

Sanitation, which includes good housekeeping practices and proper storage and handling of food materials, feed, and garbage, is often stressed as a method of rodent control. Unfortunately, even the best sanitation will not eliminate house mice. It will, however, aid in control by permitting easier detection of mouse sign, increasing effectiveness of traps and baits by reducing competing food items, and by preventing mice from flourishing and reaching high populations.

Although house mice are less dependent upon humans for their existence than are Norway rats, they are much more adaptable to living with people. They require very little space and only small amounts of food. Mice have been known to inhabit buildings even before construction has been complete, living off the crumbs and scraps of worker's lunches. In offices, mice may live behind cabinets or furniture and feed on scraps or crumbs from lunches and snacks and on cookies or candy bars kept in desks. In homes, they may find ample food in kitchens, and in the garage they will eat sacked or spilled pet food, grass seed, or insects such as cockroaches. Thus, no matter how good the sanitation, most buildings in which food is stored, prepared, or

consumed will support at least a few mice. For this reason, a constant watch must be kept for mice that may invade the premises.

Where possible, store bulk foods in rodent-proof containers or rooms. Stack sacked or boxed foods in orderly rows on pallets in a way that allows for thorough inspection for evidence of mice. In such storage areas, keep stored materials away from walls. A 12-inch (30.5-cm) white band painted on the floor next to the wall serves as a reminder to keep items away from walls. It also will allow you to detect rodent droppings or other sign more easily (Fig. 5). Sweep floors frequently to permit ready detection of fresh droppings.

When storing foods or feed on pallets, keep in mind that mice can jump up more than 12 inches (30.5 cm) from a flat surface. They are also good climbers and can walk up surfaces such as wood or concrete (unless the surfaces have a slick finish). Mice can live for considerable periods of time within a pallet of feed without coming down to the floor.

Regular removal of debris and control of weeds from around structures will reduce the amount of shelter available to rodents. In some instances, a strip of

heavy gravel placed adjacent to building foundations or other structures will reduce rodent burrowing at these locations. In any event, keep the perimeter of buildings and other structures clean of weeds and debris (including stacked lumber, firewood, and other stored materials) to discourage rodent activity and to allow easier detection of rodent sign.

### Frightening

Mice are somewhat wary animals and can be frightened by unfamiliar sounds or sounds coming from new locations. Most rodents, however, can quickly become accustomed to new sounds heard repeatedly.

For years, devices that produce ultrasonic sound that is claimed to control rodents have come and gone on the market. There is little evidence to suggest that rodents' responses to nonspecific, high-frequency sound is any different from their response to sound within the range of human hearing.

What is known about rodents and sound?

—Unusually loud, novel, or ultrasonic sounds, which rodents can hear, will frighten them and may cause temporary avoidance lasting from a few minutes to a few weeks.

What is known about ultrasonic sound?

—It is very directional and does not travel around corners well; thus, sound shadows or voids are created.

—Ultrasound does not travel very far. It loses its intensity rapidly as it leaves the source.

—Ultrasound has not been shown to drive established rodents out of buildings or areas, nor has it been proven to cause above-normal mortality in their populations. While it is possible to cause convulsions or permanent physiological damage to rodents with ultrasound, the intensity of such sounds must be so great that damage to humans or domestic animals would also be likely. Commercial ultrasonic pest control devices do not produce sound of such intensity.

Recent tests of commercial ultrasonic devices have indicated that rodents may be repelled from the immediate area of the ultrasound for a few days, but then will return and resume normal activities. Other tests have shown the degree of repellency to depend upon the particular ultrasonic frequencies used, their intensity, and the pre-existing condition of the rodent infestation. Ultrasonic sound has very limited usefulness in rodent control. The advertising claims for many

commercial devices are unsubstantiated by scientific research. Since commercial ultrasonic devices are often expensive and of questionable effectiveness, they cannot be recommended as a solution to rodent problems.

### Repellents

Rodents find some types of tastes and odors objectionable, but chemical repellents are seldom a practical solution to mouse infestations. Substances such as moth balls (naphthalene) or household ammonia, in sufficient concentration, may have at least temporary effects in keeping mice out of certain enclosed areas. These are not specifically registered by the EPA as mouse repellents, however.

Ro-pel® is registered for use in repelling house mice and other rodents from gnawing on trees, poles, fences, shrubs, garbage, and other objects. Little information is currently available on its effectiveness against house mice.

Other solutions to rodent problems, including rodent-proof construction and methods of population reduction, are usually more permanent and cost-effective than the use of repellents.

### Toxicants

Rodenticides were formerly classified into two groups, single-dose (acute)

toxicants and multiple-dose (chronic) toxicants. However, the complexity in mode of action of newer rodenticides makes these classifications outdated. A classification into two groups, the first group including all anticoagulants and the second group all other compounds (“non-anticoagulants”), is currently more useful.

**Anticoagulants (slow-acting, chronic toxicants).** House mice are susceptible to all of the various anticoagulant rodenticides (Table 1), but they are generally less sensitive (often far less sensitive) to the active ingredients than are Norway or roof rats. It usually requires a few more feedings to produce death with the first-generation anticoagulants (such as warfarin, diphacinone, and chlorophacinone) than with the second-generation anticoagulants (such as brodifacoum and bromadiolone). All anticoagulants provide good to excellent house mouse control when prepared in acceptable baits. A new second-generation anticoagulant, difethialone, is presently being developed and EPA registration is anticipated in the near future. The characteristics of the various anticoagulant rodenticides are described further under Anticoagulants in the **Pesticides** section, and in the chapter **Norway Rats**.

**Table 1. Anticoagulants used for house mouse control in the United States.**

Common name and typical trade names	Chemical name	Usual types of formulations			Percent active ingredient used in food bait
		Food bait	Liquid	Tracking powder	
<i>Hydroxycoumarins</i>					
Warfarin (Final® and others)	3-( $\alpha$ -acetonylbenzyl)-4-hydroxycoumarin	X	X		0.025
Brodifacoum (Talon®)*	3-[3(4'-bromo[1,1'biphenyl]-4-yl)-1,2,3,4-tetrahydro-1-naphthalenyl]-4-hydroxy-2H-1-benzopyran-2-one	X			0.005
Bromadiolone (Maki®, Contrac®)*	3-[3-(4'-bromo[1,1'biphenyl]-4-yl)-3-hydroxy-1-phenylpropyl]-4-hydroxy-2H-1-benzopyran-2-one	X			0.005
Difethialone*	[(bromo-4'-[biphenyl-1-1']-yl-4)3-tetrahydro-1,2,3,4-naphthyl-1]3-hydroxy-4,2H-1-benzo-thiopyran-2-one	X			0.0025
<i>Indandiones</i>					
Chlorophacinone (RoZol®)	2-[( <i>p</i> -chlorophenyl)phenylacetyl]-1,3-indandione	X		X	0.005
Diphacinone (Ditrac®)	2-diphenylacetyl-1,3-indandione	X		X	0.005
Pindone (Pival®, Pivalyn®)	2-pivalyl-1,3-indandione	X	X		0.025

\* Second-generation anticoagulants especially useful for the control of warfarin-resistant rats and mice.



Because of their similarity in mode of action, all anticoagulant baits are used in a similar fashion. Label directions commonly instruct the user to “maintain a continuous supply of bait for 15 days or until feeding ceases,” thus ensuring that the entire mouse population has ample opportunity to ingest a lethal dose of the bait. Anticoagulants have the same effect on nearly all warm-blooded animals, but the sensitivity to these toxicants varies among species. If misused, anticoagulant rodenticides can be lethal to nontarget animals such as dogs, pigs, and cats. Additionally, residues of anticoagulants which are present in the bodies of dead or dying rodents can cause toxic effects to scavengers and predators. In general, however, the secondary poisoning hazard from anticoagulants is relatively low.

Brodifacoum and bromadiolone baits, because of their potential to be lethal in a single feeding, can be more effective than the other anticoagulants in certain situations. Chlorophacinone (RoZol®) and diphacinone (Ditrac®) are similar to each other in potency and are more toxic than the anticoagulant compounds developed earlier. Thus, they are formulated at lower concentrations. Chlorophacinone and diphacinone may kill some mice in a single feeding, but multiple feedings are needed to give adequate control of a mouse population.

Pindone (Pival®, Pivalyn®) is also less potent than chlorophacinone or diphacinone, and is similar to warfarin in effectiveness against house mice. It has some properties that resist insects and growth of mold in prepared baits.

Warfarin (Final® and other trade names) was the first marketed anticoagulant and is, therefore, the best known and most widely used. It is effective against house mice, although some warfarin contains small quantities of contaminants that apparently can reduce bait acceptance. This has been resolved with the development of encapsulated warfarin.

**Anticoagulant Resistance.** Within any population of house mice, some

individuals are less sensitive to anticoagulants than others. Where anticoagulants have been used over long periods of time at a particular location, there is an increased potential for the existence of a population that is somewhat resistant to the lethal effects of the baits. Such resistant populations of house mice have been identified at a number of locations throughout the United States. Although not common, resistance may be underestimated because relatively few resistance studies have been conducted on house mice. Nevertheless, resistance is of little consequence in the control of house mice with the newer rodenticides available. When anticoagulant resistance to the first-generation anticoagulants is known or suspected, use of these compounds should be avoided in favor of the second-generation anticoagulants or one of the non-anticoagulant products.

#### **Anticoagulant Bait Failure.**

Resistance is only one (and perhaps the least likely) reason for failure in the control of mice with anticoagulant baits. Control with baits that are highly accepted may fail for one or more of the following reasons:

- Too short a period of bait exposure.
- Insufficient bait and insufficient replenishment of bait (none remains from one baiting to the next).
- Too few bait stations and/or too far apart. For mice, stations should be within 6 feet (2 m) of one another in areas where mice are active.
- Too small a control area, permitting mice to move in from untreated adjacent areas.
- Genetic resistance to the anticoagulant. Although this is unlikely, it should be suspected if about the same amount of bait is taken daily for several weeks.

Reasons for failure to achieve control with anticoagulant baits that are poorly accepted:

- Poor bait choice, or bait formulated improperly. Other foods are more attractive to the mice.

- Improperly placed bait stations. Other foods are more convenient to the mice.
- Abundance of other food choices.
- Tainted bait: the bait has become moldy, rancid, insect-infested, or contaminated with other material that reduces acceptance. Discard old bait periodically, and replace it with fresh.

Occasionally, mice accept bait well and an initial population reduction is successful. Then bait acceptance appears to stop although some mice remain. In such instances, it is likely that the remaining mice never accepted the bait, either because of its formulation or placement. The best strategy is to switch to a different bait formulation, place baits at different locations, and/or use other control methods such as traps.

**Other Rodenticides.** The older rodenticides, formerly referred to as acute toxicants, such as arsenic trioxide, phosphorus, strychnine, and Compound 1080, are no longer registered for house mice. Newer rodenticides are much more effective and have resulted in the phasing out of these older materials over the last 20 years.

At present, three non-anticoagulant rodenticides (Table 2) are registered by EPA against house mice: bromethalin, cholecalciferol (vitamin D<sub>3</sub>), and zinc phosphide. All are potentially useful for controlling anticoagulant-resistant populations of house mice.

Of these active ingredients, bromethalin and cholecalciferol are formulated to serve as chronic rodenticides, applied so that house mice will have the opportunity to feed on the baits one or more times over the period of one to several days. Bait acceptance is generally good when formulations appropriate for house mice are selected. Zinc phosphide differs from the other two compounds in that prebaiting (offering mice similar but nontoxic bait prior to applying the zinc phosphide-treated bait) is recommended to increase bait acceptance. Zinc phosphide baits are not designed to be left

**Table 2. Other (non-anticoagulant) rodenticides used to control house mice in the United States.**

Common Name	Chemical Name	Acute oral LD <sub>50</sub> for mice, mg/kg	Time to death	Odor	Taste	Percent active ingredient in food bait	Relative hazard	Mode of Action
Bromethalin (Assault®, Vengeance®)	N-methyl-2,4-dinitro-N-(2,4,6-tribromophenyl)-6-(trifluoromethyl)benzenamine	5.25-8.13	2-4 days	None	Slight	0.01	Moderate	Central nervous system depression and paralysis
Cholecalciferol (vitamin D <sub>3</sub> , Quintox®)	9,10-Seocholesta-5,7,10 (19)-trein-3 betaol	42.5	3-4 days	Slight	None	0.075	Low to moderate	Mobilizes calcium resulting in death from hypercalcemia
Zinc phosphide	Zinc phosphide	40	1/2-20 hours	Strong	Strong	1.0-2.0	Moderate	Phosphine gas enters circulatory system; heart paralysis, gastrointestinal and liver damage

available to mice for more than a few days, as continued exposure is likely to result in bait shyness within the population. Be sure to follow label recommendations on any specific product to achieve best success.

### Bait Selection and Formulation

Oatmeal, ground or rolled wheat, rolled barley, ground or rolled milo, and corn have been successfully used as chief ingredients of toxic baits for house mice. Grass seed, such as whole canary grass seed (*Phalaris canariensis*), is often highly accepted by house mice and can be very effective as a principal bait ingredient. In general, the fresher the bait, the better it will be accepted by mice. Rodent baits should always be made from high-quality food materials, and baits should be replaced or replenished regularly.

Food preferences may vary among mouse populations and individuals. Bait materials similar to foods mice are

accustomed to eating are often a good choice, particularly if their normal foods are limited or can be made less available to them. In past years, many people involved in house mouse control preferred to mix their own baits so as to tailor them to the food preference of a specific mouse population. Today, there is a wide selection of ready-to-use baits which are commercially available. It is still important, particularly in moderate- to large-scale mouse control programs, to check for differences in bait acceptance among candidate baits prior to investing time and money in a specific bait product. Place about 1/2 ounce (14 g) of each of several ready-to-use baits about 4 inches (10 cm) apart in several locations where mice are present. Check baits the next day to see which ones are preferred.

Ready-to-use baits come in a variety of formulations. Grain-based baits in a loose meal or pelleted form are

available in bulk or packaged in small plastic, cellophane, or paper “place packs” (Fig. 6). These packets keep bait fresh and make it easy to place baits into burrows, walls, or other locations. Mice will gnaw into these bags to feed on an acceptable bait. Pelleted baits can more easily be carried by mice to other locations. Such hoarding of food by mice is not uncommon. It may result in amounts of bait being moved to places where it is undetected or difficult to recover and may, if accessible, be hazardous to nontarget species. On the other hand, pelleted bait avoids some problems common to loose baits — settling out of different-sized particles during shipment and uneven mixing of the toxicant. Pellets are easily manipulated by mice, increasing the attractiveness of this form of bait.

Anticoagulant baits have also been formulated into wax and extruded blocks (Fig. 7). These are particularly useful where moisture may cause loose grain

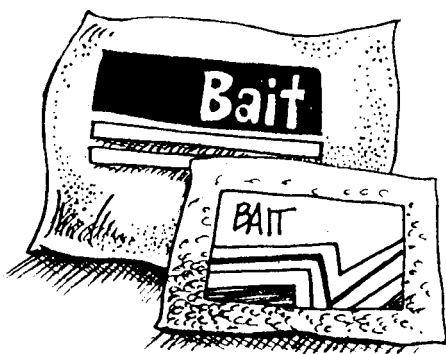

Fig. 6. Various types of place packs containing rodenticides are commercially available.

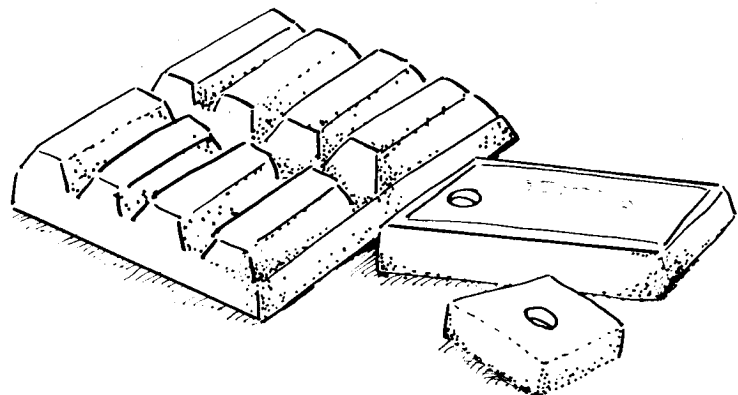

Fig. 7. Wax and extruded bait blocks are useful in damp locations where loose baits become spoiled quickly.

baits to spoil. Mice accept paraffin block baits less readily than loose or pelleted grain baits, but acceptance of extruded bait blocks is high.

Where no water is available, water or food items of high moisture content are often more readily accepted than dry baits. Sodium salts of anticoagulants are available as concentrates to be mixed with water, making a liquid bait (Fig. 8). Although mice require little or no water to survive, they will readily drink it when available. Water baits can be an effective supplement to other control measures where water is scarce. They are particularly useful in grain storage structures, warehouses, and other such locations. Rodents are more easily able to detect anticoagulants in water baits than in food baits; therefore, up to 5% sugar is sometimes added to liquid baits to increase rodents' acceptance of the bait solution. Since water is attractive to most animals, use water baits in ways that prevent nontarget animals from drinking them.

### Bait Stations

Bait stations (bait boxes) may increase both the effectiveness and safety of rodenticides. They came into general use after the development of the first-generation anticoagulants, which require that a continuous supply of bait be made available to rodents. Bait stations are useful because they:

- protect bait from moisture and dust;

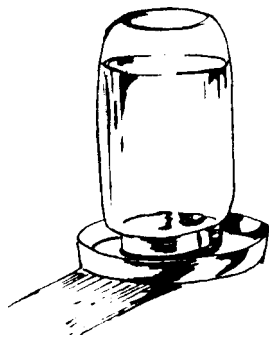

Fig. 8. Liquid baits can be placed in vials or other similar containers.

- provide a protected place for rodents to feed, allowing them to feel more secure. This is an important advantage when baiting mice, which apparently like to spend time feeding inside such bait boxes;
- keep other animals (pets, livestock, desirable wildlife) and children away from hazardous bait;
- allow placement of bait in locations where it would otherwise be difficult because of weather or potential hazards to nontarget animals;
- help prevent the accidental spilling of bait;
- allow easy inspection of bait to see if rodents are feeding on it.

**Kinds of Bait Stations.** Bait stations can contain solid baits (food baits), liquid baits, or both. Bait boxes can be purchased from commercial suppliers or made at home. Manufactured bait boxes made of plastic, cardboard, or metal are sold to pest control companies and to the public (Fig. 9) in sizes for rats or mice. Some farm supply and agricultural chemical supply stores have them in stock or can order them. Recent research suggests mice may prefer to feed in cardboard bait stations rather than plastic ones.

Bait boxes can be built from scrap materials, and homemade stations can be designed to fit individual needs. Make them out of sturdy materials so they cannot be easily knocked out of place

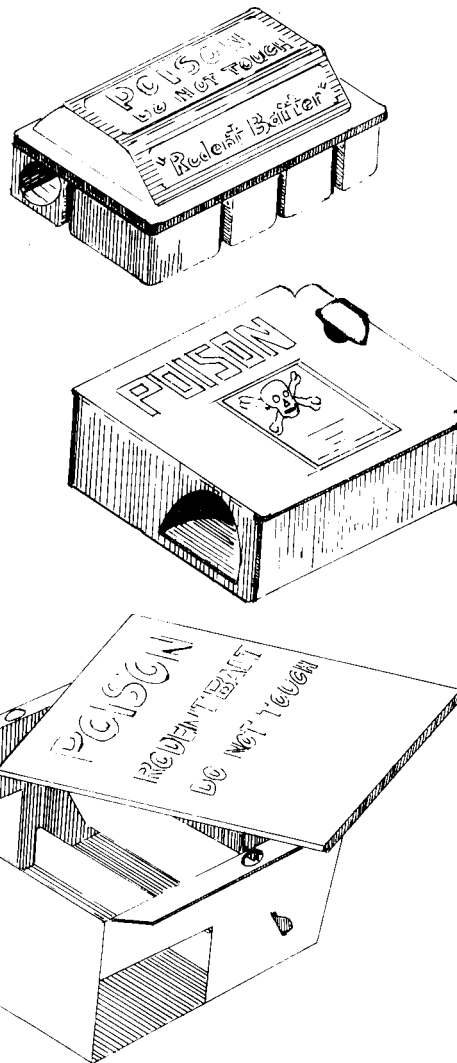

Fig. 9. Examples of commercially manufactured rodent bait stations.

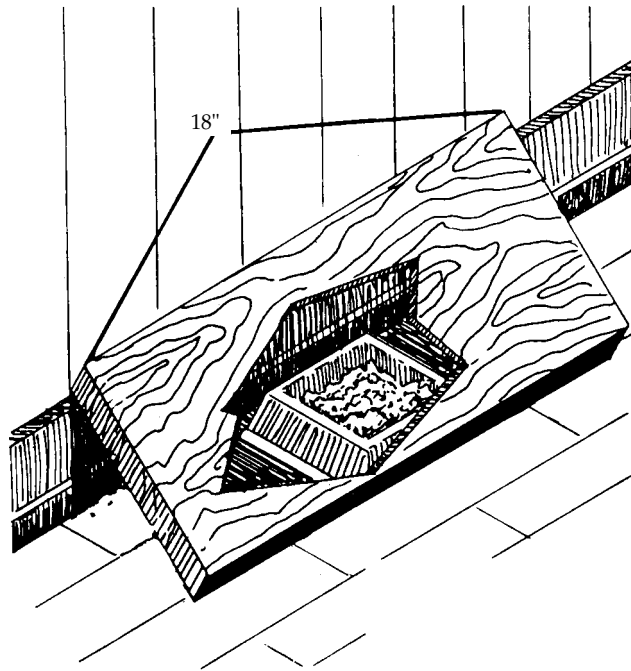

Fig. 10. A flat board nailed to a wall protects rodent bait from nontarget animals and allows rodents to feed in a sheltered location. The board should be at least 18 inches (45.7 cm) long to keep pets and children from reaching the bait.

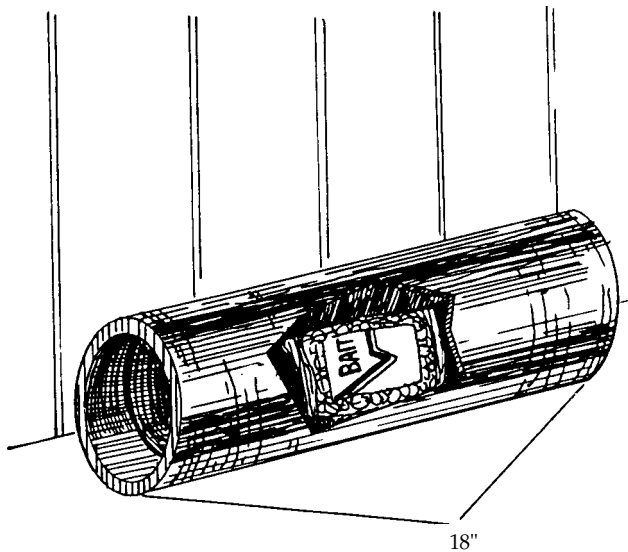

Fig. 11. Rodent bait station made from a length of pipe. Pipe diameter can be 2 to 3 inches (5.1 to 7.6 cm) for mice; 3 1/2 to 6 inches (8.9 to 15.2 cm) for rats.

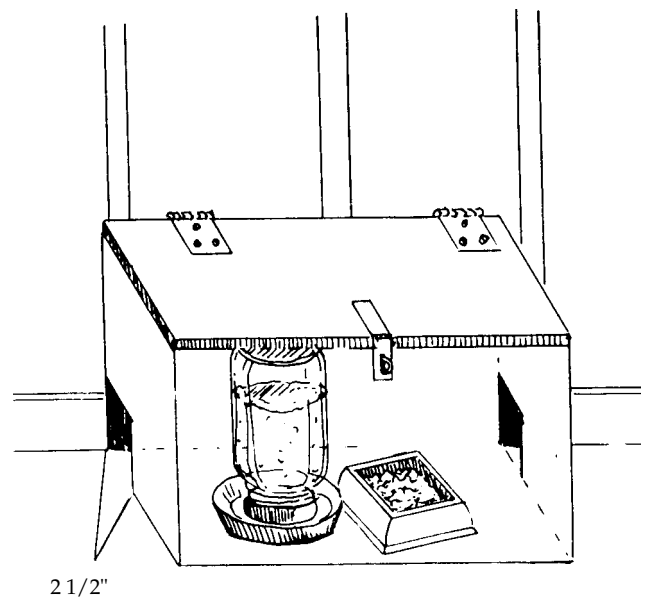

Fig. 12. A homemade rodent bait station can contain liquid as well as solid baits.

or damaged. Where children, pets, or livestock are present, be careful to construct the stations so that the bait is accessible only to rodents. Locks, seals, or concealed latches are often used to make bait boxes more tamperproof. Clearly label all bait boxes or stations with "Poison" or "Rodent Bait — Do Not Touch," or with a similar warning. Some rodenticides or situations may require use of tamper-resistance bait stations. If so, use only bait boxes or stations which are so designated, and also be sure to secure them to buildings by nailing or gluing them to walls or floors in a way that will not permit a person or animal to knock them over or shake the bait out.

**Bait Station Design.** Bait stations should be large enough to allow several rodents to feed at once. They can be as simple as a flat board nailed at an angle to the bottom of a wall (Fig. 10), or a length of pipe into which bait can be placed (Fig. 11). More elaborate stations are completely enclosed and can contain liquid as well as solid rodent baits (Fig. 12). A hinged lid with a child-proof latch can be used for convenience in inspecting permanent stations.

Bait stations for mice should have at least two openings approximately 1 inch (2.5 cm) in diameter. Locate the two holes on opposite sides of the station so that mice can see an alternate escape route as they enter the station.

**Bait Station Maintenance.** Baits must be fresh and of high quality. Mice may reject spoiled or stale foods. Provide enough fresh bait to allow rodents to eat all they want. When using rodenticides designed for continuous bait application (such as anti-coagulants), bait station maintenance is essential to a successful baiting effort. When bait boxes are first put out, check them daily and add fresh bait as needed. After a short time, as rodent numbers and feeding decline, check the boxes once every 2 to 4 weeks. If the bait becomes moldy, musty, soiled, or insect-infested, empty the box and clean it, and then refill it with fresh bait. Dispose of spoiled or uneaten bait in accordance with the label. Follow all label directions for the product you are using.

**Placement of Bait Stations.** House mice are active in a small area and lack notable food preferences. Therefore, proper placement of baits or bait stations is often more important than the type of bait used. Mice will not visit bait stations, regardless of their contents, if not conveniently located in areas where they are active.

Where possible, place bait between the rodents' source of shelter and their food supply. Put bait boxes near rodent burrows, against walls or along travel routes. Where mice are living in sacked or boxed feed on pallets, baits or traps may have to be placed on top of stacks or wedged in gaps within the stacks. In such situations, this "three dimensional" bait placement is important to obtain good control. Caution should be used in selecting control methods in such situations. Do not use baits that will contaminate foodstuffs. For safety, it may not be wise to use toxic baits in the vicinity of certain foodstuffs. Traps or glue boards may be used instead.

On farmsteads, bait station placement depends on building design and use.

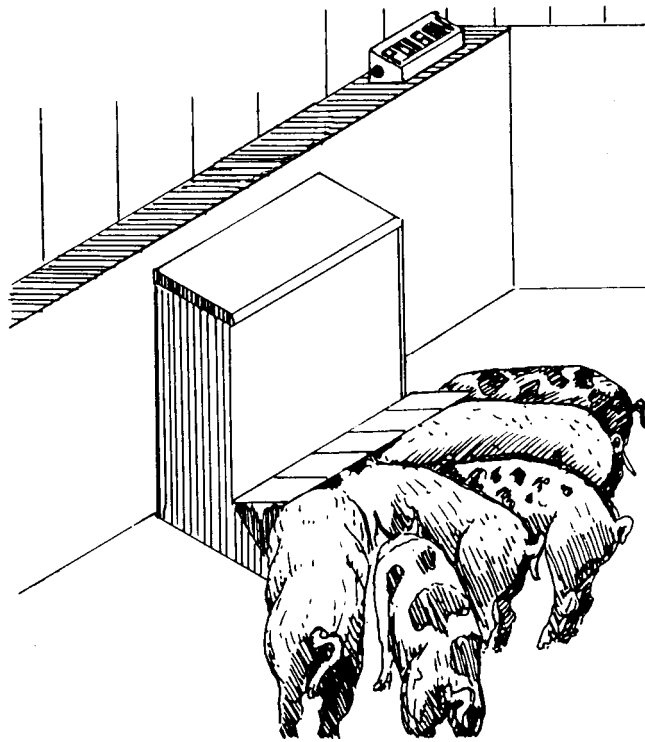

Fig. 13. Rodent bait box attached to the top of open dividing wall in a swine confinement facility. When used in such locations, bait boxes must be securely fastened and out of pigs' reach.

For example, in swine confinement buildings it may be possible to attach bait boxes to wall ledges or the top of pen dividing walls. Bait boxes may be placed in attics or along floors or alleys where rodents are active (Fig. 13). Rodent tracks visible on dusty surfaces and their droppings often give clues to where they are active.

Never place bait stations where livestock, pets, or other animals can knock them over. Spilled bait may be a potential hazard, particularly to smaller animals.

Where buildings are not rodent-proof, permanent bait stations can be placed inside buildings, along the outside of building foundations, or around the perimeter. Bait stations will help keep rodent numbers at a low level when maintained regularly with fresh anti-coagulant bait. Rodents moving in from nearby areas will be controlled before they can reproduce and cause serious damage.

**Tracking Powders.** Toxic dusts or powders have been successfully used for many years to control mice and rats. When mice walk over a patch of

toxic powder, they pick some of it up on their feet and fur and later ingest it while grooming. Tracking powders are useful in controlling mice where food is plentiful and good bait acceptance is difficult to achieve. Mice are more likely to ingest a lethal amount of a poorly accepted toxicant applied by this method than if it is mixed into a bait material. There is little likelihood of toxicant shyness developing when using tracking powders.

Because the amount of material a mouse may ingest while grooming is small, the concentration of active ingredient in tracking powders is considerably higher than in food baits that utilize the same toxicant. Therefore, these materials can be more hazardous than food baits. For the most part, tracking powders are used by professional pest control operators and others trained in rodent control. Tracking powders containing either zinc phosphide or anticoagulants are commercially available, although some are Restricted Use Pesticides.

Place tracking powders along runways, in walls, behind boards along

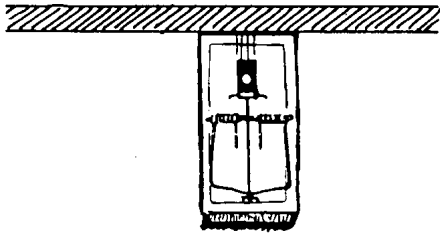

Single trap set with trigger next to wall.

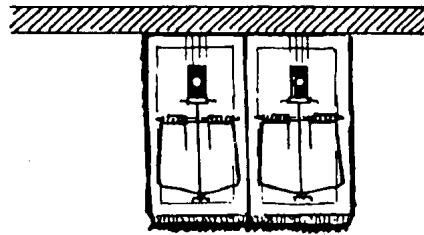

The double set increases your success.

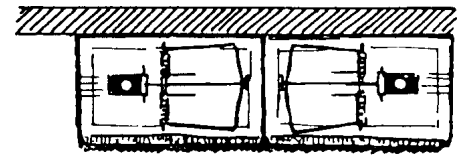

Double set placed parallel to the wall with triggers to the outside.

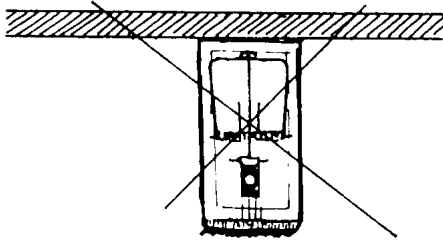

Wrong—trigger not next to wall.

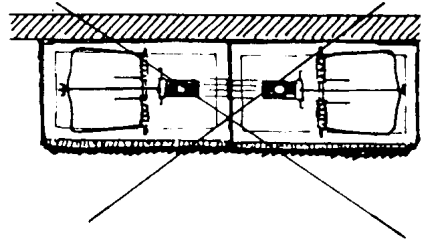

Wrong—parallel set with triggers on the inside.

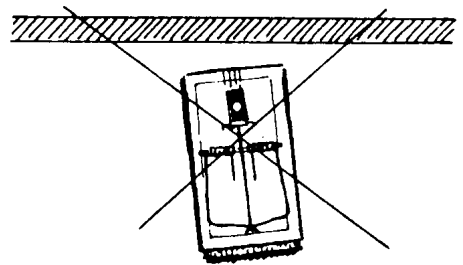

Wrong—trap too far from wall.

Fig. 14. Placement of snap traps.

walls, or on the floor of bait stations. Placement can be aided by using various types of sifters, shakers, or blowers. Dampness may cause the powder to cake and lessen its effectiveness. Care must be taken to place tracking powders only where they cannot contaminate food or animal feed, or where nontarget animals cannot come into contact with them. Do not place tracking powders where mice can track the material onto food intended for use by humans or domestic animals. Tracking powders are not generally recommended for use in and around homes because of the potential hazards to children and pets. Where possible, remove tracking powder after the rodent control program is completed. Tracking powders used in conjunction with baiting can provide very effective mouse control.

### Fumigants

Fumigants (toxic gases) are most commonly used to control mice in structures or containers such as feed bins, railway cars, or other enclosed areas. Aluminum phosphide, chloropicrin, and methyl bromide are currently registered for this purpose. Some fumigant materials are registered for use in rodent burrows; however, house mouse burrows cannot be fumigated

efficiently or economically because they are small and often difficult to find. Generally, control of house mice by fumigation is only practical and cost-effective in a very limited number of situations. Fumigants are hazardous materials and should be applied only by persons well trained in their use and who possess the necessary safety equipment.

### Trapping

Trapping can be an effective method of controlling mice, but it requires more labor than most other methods. Trapping is recommended where poisons seem inadvisable. It is the preferred method to try first in homes, garages, and other small structures where there may be only a few mice present.

Trapping has several advantages: (1) it does not rely on inherently hazardous rodenticides; (2) it permits the user to view his or her success; and (3) it allows for disposal of the mice, thereby eliminating odor problems from decomposing carcasses that may remain when poisoning is done within buildings.

The simple, inexpensive, wood-based snap trap is available in most hardware and farm supply stores. Traps should be baited with a small piece of

nutmeat, chocolate candy, dried fruit, or bacon tied securely to the trigger. Peanut butter or marshmallows also may be used as bait. Because mice are always in search of nesting materials, a small cotton ball will also work as a bait when attached securely to the trigger. Food baits that become stale lose their effectiveness.

Set traps close to walls, behind objects, in dark places, and in locations where mouse activity is seen. Place the traps so that when mice follow their natural course of travel (usually close to a wall) they will pass directly over the trigger (Fig. 14). Set traps so that the trigger is sensitive and will spring easily. Effectiveness can be increased by enlarging the trigger. Attach a square of cardboard, metal, or screen wire that fits just inside the wire deadfall (Fig. 15).

Use enough traps to make the campaign short and decisive. Mice seldom venture far from their shelter and food supply, so traps should be spaced no more than about 6 feet (1.8 m) apart in areas where mice are active. Although mice are not nearly as afraid of new objects as rats are, leaving the traps baited but unset until the bait is taken at least once will reduce the chance of mice escaping the trap and becoming trap-shy.

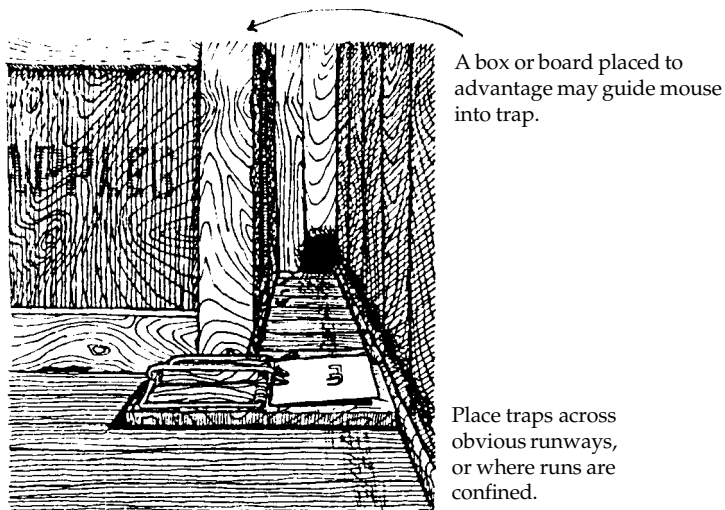
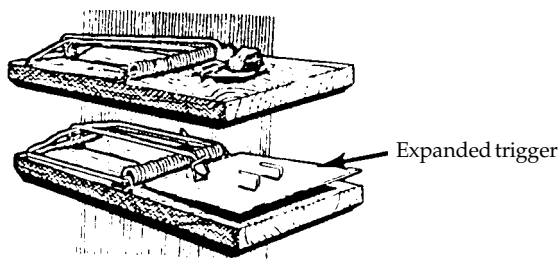

Fig. 15. Expanded-trigger traps, when properly placed, can be very effective.

Multiple-capture (automatic) mouse traps such as the Ketch-All® and Victor Tin Cat® (Fig. 16) are available from some hardware and farm supply stores as well as from pest control equipment distributors. These traps work on the principle that mice enter small holes without hesitation. The Ketch-All® has a wind-up spring that powers a rotating mechanism. When triggered, the mechanism entraps mice in a holding compartment. The Tin Cat® has one-way doors that mice cannot exit. Such traps may catch many mice in a single setting, but should be checked and emptied periodically so that mice do not die of starvation or exposure in the traps.

Various types of box-type traps (Sherman-type and others) that capture one mouse at a setting are used primarily for research purposes. The desire to “build a better mousetrap” keeps a variety of traps of variable effectiveness coming and going on the retail market.

Keep traps reasonably clean and in good working condition. They can be cleaned with a hot detergent solution and a stiff brush. Human and dead-mouse odors on traps are not known to reduce trapping success.

An alternative to traps are glue boards, which catch and hold mice attempting to cross them, much the way flypaper catches flies. Place glue boards wherever mice travel—along walls or in established runways. Do not use glue boards where children, pets, or desirable wildlife can contact them. Glue boards lose their effectiveness in dusty areas unless covered, and temperature extremes may affect the tackiness of some glues. They are considered less effective for capturing rats than for mice. Glue boards can be purchased ready-to-use, or they can be made.

Euthanize live, trapped rodents by carbon dioxide asphyxiation or use a stick to kill them with sharp blows to the base of the skull. For further information on glue boards, see the section **Supplies and Materials**.

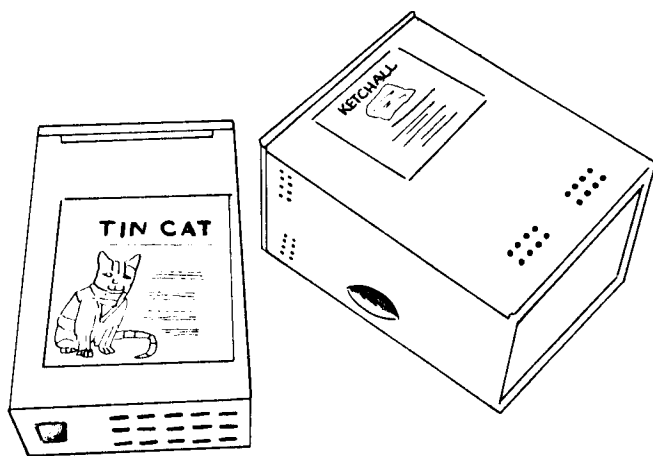

Fig. 16. Automatic multiple-capture mouse traps are commercially available (for example: *left*, Tin Cat®; *right*, Ketch-All®).

## Other Methods

Some dogs and cats will catch and kill mice and rats. There are few situations, however, in which they will do so sufficiently to control rodent populations. Around most structures, mice can find many places to hide and rear their young out of the reach of such predators. Cats probably cannot eliminate existing mouse populations, but in some situations they may be able to prevent reinfestations once mice have been controlled. Farm cats, if sufficient in number and supplementally fed, may serve this function.

In urban and suburban areas, it is not uncommon to find rodents living in close association with cats and dogs, relying on cat and dog food for nourishment. Mice frequently live beneath dog houses and soon learn they can feed on their food when they are absent or asleep.

## Economics of Damage and Control

Accurate data on mouse damage, control, and their cost are difficult to obtain. Estimates of losses of food-stuffs, structural damage, and the amount of labor and materials expended to control mice are usually only educated guesses.

In one survey of corn in a midwestern state, 76% of about 1,000 grain samples were contaminated with rodent droppings. Mouse droppings outnumbered rat droppings twelve to one. A house mouse produces about 36,000 droppings in a year's time. Mouse infestations are so widespread that droppings and hairs often end up in many types of food commodities intended for human use. Certain levels of rodent contamination are grounds for condemning food commodities.

Structural damage caused by rodents can be expensive. In recent years, the trend toward use of insulated confinement facilities to raise swine in the northern Great Plains has led to an

increased amount of rodent damage. Mice, in particular, are very destructive to rigid foam, fiberglass batt, and other types of insulation in walls and attics of such facilities. In one small swine finishing building near Lincoln, Nebraska, rodent damage required the producer to spend \$5,000 in repairs to the facility only 3 years after initial construction.

## Acknowledgments

I thank Rex E. Marsh for reviewing a previous version of this chapter and providing many helpful comments. Portions of the recommendations on toxicant use are taken directly from his chapter **Roof Rats** in this manual. Other material contained in this chapter is derived from Brooks (1973), Marsh and Howard (1981), and Pratt et al. (1977), among other sources.

Figure 1 is from Schwartz and Schwartz (1981).

Figures 2, 5, and 15 were adapted from Pratt et al. (1977) by Jill Sack Johnson.

Figures 3 and 14 were adapted from Howard and Marsh (1981) by Jill Sack Johnson.

Figure 4 from Hygnstrom and Virchow (1992).

Figures 6, 7, and 8 were developed by Jill Sack Johnson.

Figures 9, 12, and 13 are by Frances I. Gould, University of Nebraska-Lincoln, Cooperative Extension.

Figures 10 and 11 were adapted from Pratt et al. (1977) by Frances I. Gould.

## For Additional Information

Berry, R. J. 1981. Town mouse, country mouse: adaptation and adaptability in *Mus domesticus* (*M. musculus* d). *Mammal Rev.* 11:91-136.

Berry, R. J., ed. 1981. Biology of the house mouse. *Symp. Zool. Soc. London*, No. 47. 715 pp.

Bohills, S. T., A. P. Meehan, and S. P. Leonard. 1982. Advantages of bait boxes in house mouse control. *International Pest Control* 24(2):34, 35, 37.

Bronson, F. H. 1979. The reproductive ecology of the house mouse. *Quarterly Rev. Biol.* 54(3):265-299.

Brooks, J. E. 1973. A review of commensal rodents and their control. *CRC Critical Rev. Environ. Control* 3:405-453.

Burt, W. H., and R. P. Grossenheider. 1976. A field guide to the mammals, 3rd ed. Houghton Mifflin Co., Boston. 289 pp.

Chitty, D., and H. N. Southern. 1954. Control of rats and mice, vol. 1-3. Clarendon Press, Oxford.

Corrigan, R. M., C. A. Towell, and R. E. Williams. 1992. Development of rodent control technology for confined swine facilities. *Proc. Vertebr. Pest Conf.* 15:280-285.

Crowcroft, P., and J. N. R. Jeffers. 1961. Variability in the behavior of wild house mice (*Mus musculus* L.) towards live traps. *Proc. Zool. Soc. London* 137:573-582.

Davis, D. E. 1981. Environmental control of rodents. Pages 493-498 in D. Pimentel, ed. *CRC handbook of pest management in agriculture*, vol. 1. CRC Press, Inc., Boca Raton, Florida.

Fitzwater, W. D. 1982. Bird limes and rat glues — sticky situations. *Proc. Vertebr. Pest Conf.* 10:17-20.

Frantz, S. C., and D. E. Davis. 1991. Bionomics and integrated pest management of commensal rodents. Pages 243-313 in J. R. Gorham, ed. *Ecology and management of food-industry pests*. Food Drug Admin. Tech. Bull. 4, Assoc. Official Analytical Chem. Arlington, VA.

Haines, H., and K. Schmidt-Neilsen. 1967. Water deprivation in wild house mice. *Physiol. Zool.* 40:424-431.

Howard, W. E., and R. E. Marsh. 1981. The rat: its biology and control. Div. Agric. Sci. Univ. California, Leaflet 2896 (revised). 30 pp.

Humphries, R. E., A. P. Meehan, and R. M. Sibly. 1992. The characteristics and history of behavioural resistance in inner-city house mice (*Mus domesticus*) in the U.K. *Proc. Vertebr. Pest Conf.* 15:161-164.

Hygnstrom, S. E., and D. R. Virchow. 1992. Controlling house mice. Univ. Nebraska Coop. Ext. NebGuide G92-1105-A. 4 pp.

Jackson, W. B. 1990. Rats and mice. Pages 9-85 in A. Mallis, ed. *Handbook of pest control*. Franzak and Foster Co., Cleveland, OH.

Kaukeinen, D. E. 1982. A review of the secondary poisoning hazard potential to wildlife from the use of anticoagulant rodenticides. *Proc. Vertebr. Pest Conf.* 10:151-158.

Kaukeinen, D. E. 1984. Resistance: what we need to know. *Pest Manage.* 3(3):26-30.

Knote, C. E. 1988. Stopping house mice building infestations through exterior control. *Proc. Vertebr. Pest Conf.* 13:107-111.



- Labov, J. B. 1981. Male social status, physiology, and ability to block pregnancies in female house mice (*Mus musculus*). Behav. Ecol. Sociobiol. 8:287-291.
- Marsh, R. E., and W. E. Howard. 1981. The house mouse: its biology and control. Div. Agric. Sci. Univ. California, Leaflet 2945 (revised). 30 pp.
- Meehan, A. P. 1984. Rats and mice: their biology and control. Rentokil Ltd., E. Grinstead, U.K. 383 pp.
- Morris, K. D., and D. E. Kaukeinen. 1988. Comparative evaluation of tamper-proof mouse bait stations. Proc. Vertebr. Pest Conf. 13:101-106.
- Petras, M. L., and J. C. Topping. 1981. Studies of natural populations of *Mus*. VI. Sizes of populations inhabiting corn cribs in southwestern Ontario. J. Mammal. 62:146-153.
- Pratt, H. D., B. F. Bjornson, and K. S. Littig. 1977. Control of domestic rats and mice. Public Health Serv., US Dep. Health, Educ. Welfare, Pub. No. (CDC) 77-841. 47 pp.
- Robbins, R. J. 1980. Taste-aversion learning and its implications for rodent control. Proc. Vertebr. Pest Conf. 9:114-121.
- Rowe, F. P. 1966. Economic importance of the house mouse (*Mus musculus* L.). World Health Organiz., Vector Control, Pub. 66.217, paper 1.4:21-26.
- Schwartz, C. W., and E. R. Schwartz. 1981. House mouse. Pages 248-252 in The wild mammals of Missouri, rev. ed. Univ. Missouri Press, Columbia. 356 pp.
- Shenker, A. M. 1973. The house mouse in London. Mammal Rev. 3:64-69.
- Weber, W. J. 1982. Diseases transmitted by rats and mice. Thomson Pub. Fresno, California. 182 pp.

### **Editors**

Scott E. Hygnstrom  
Robert M. Timm  
Gary E. Larson