

University of Nebraska - Lincoln

DigitalCommons@University of Nebraska - Lincoln

Historical Materials from University of Nebraska-
Lincoln Extension

Extension

1969

EC69-451 The Trial Muslin Garment

Jane Spence

Follow this and additional works at: <http://digitalcommons.unl.edu/extensionhist>

Spence, Jane, "EC69-451 The Trial Muslin Garment" (1969). *Historical Materials from University of Nebraska-Lincoln Extension*. 3920.
<http://digitalcommons.unl.edu/extensionhist/3920>

This Article is brought to you for free and open access by the Extension at DigitalCommons@University of Nebraska - Lincoln. It has been accepted for inclusion in Historical Materials from University of Nebraska-Lincoln Extension by an authorized administrator of DigitalCommons@University of Nebraska - Lincoln.

AGRI
S
85
E7
#109-451

THE TRIAL MUSLIN GARMENT

by Jane Speece
Extension Specialist (Clothing)

Patterns come in standard sizes, but women, unfortunately, do not. Bone structure and body flesh vary from woman to woman. Construction of the basic muslin (of unbleached muslin or an old sheet) garment enables a woman to work out the differences between measurements of her figure and measurements of a pattern.

The differences are noted, altered in the basic muslin garment, and recorded for future pattern alterations. The major pattern companies offer patterns for making a basic garment. Any simple, round-necked garment with a waistline center front opening and set-in sleeves may be used.

MAKING THE BASIC MUSLIN

Accuracy is as important in the basic muslin as it is in a fine fabric. Cut out the pattern pieces with care following the proper grain lines and transfer all *pattern* markings to the right side of the muslin. Mark all seam lines so that any alterations may be easily transferred to a paper pattern. Mark the crosswise and lengthwise grain lines at the designated points as shown in Illustrations 1, 2, and 3.

No edges will be finished. Armhole, neckline and wrist edges should be stitched at the seam line and clipped up to the seam allowance for accurate observation. Hems are folded back and pressed. Darts may be stitched on the outside to enable easier fitting. A machine basting stitch is used.

Assemble the bodice and sleeves first to check the fit, then add the skirt, finally check overall fit.

POINTS TO CHECK ON THE BODICE

Crosswise grain lines at chest, bust, waist and on the back are parallel to the floor.

Lengthwise grain lines at center front and center back are vertical to the floor.

ILLUSTRATION 1

(a) BODICE FRONT

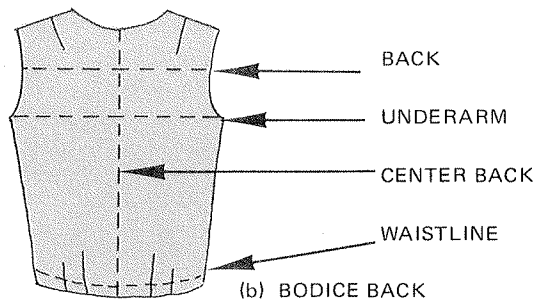
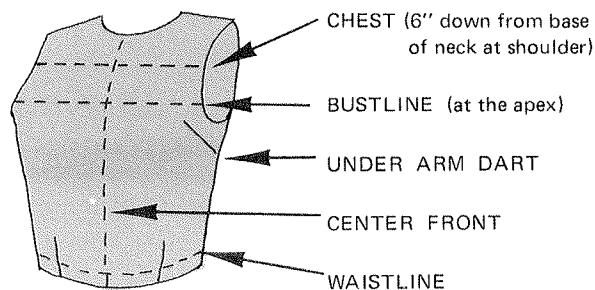

(b) BODICE BACK

Shoulder seam lies straight along the top of the shoulder. Armscye seam falls from the tip of the shoulder bone to the break under the arm. It appears as a straight line.

Armscye seam lies smoothly without gaps or wrinkles.

Neckline fits smoothly without gaps or wrinkles.

Front bodice darts point directly at the fullest part of the bust and end about 1" from the crown of the bust.

Ease is allowed in both back and front bodice with no gaps or wrinkles.

POINTS TO CHECK ON THE SLEEVE

Elbow dart points directly to the point of the elbow when the arm is bent. If there are two elbow darts, the bend should be between the two. If three darts, the bend is located at the middle dart.

ILLUSTRATION 2

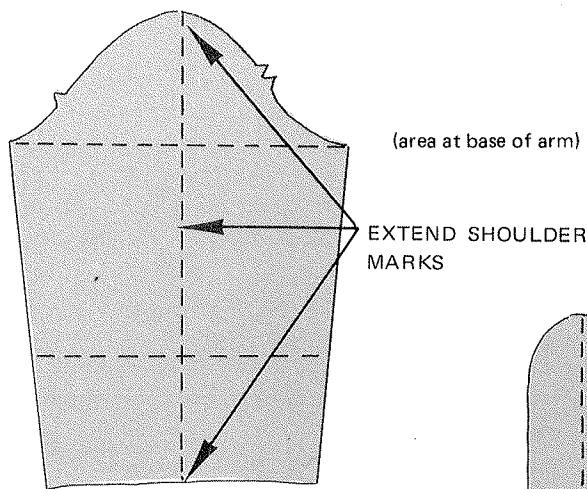

(a) SLEEVE

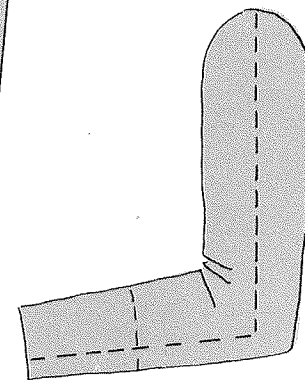

(b) BEND ELBOW TO TEST

Marked crosswise grain lines lie parallel to the floor. Marked lengthwise grain lines lie vertical to the floor.

Ease is allowed, but no gaps or wrinkles should appear in either the upper or lower arm.



POINTS TO CHECK ON THE SKIRT

Attach the skirt to the blouse before checking.

Crosswise grain line at hip is parallel to the floor.

Center front and center back are vertical to the floor.

Side seams are straight, lie halfway between the front and back and are vertical to the floor. Seam lines should correspond with bodice side seams.

Hip darts point to the fullest part of the hip.

Sufficient ease is allowed for sitting and bending, but no wrinkles or gaps show.

Skirt darts correspond with bodice darts.

ILLUSTRATION 3

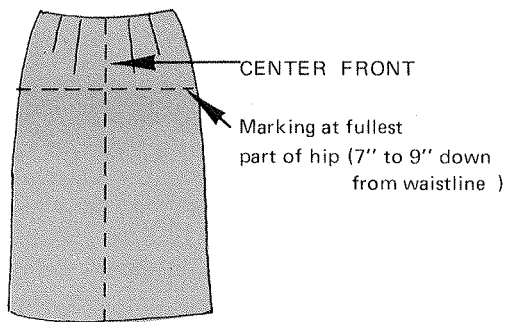

(a) CENTER FRONT

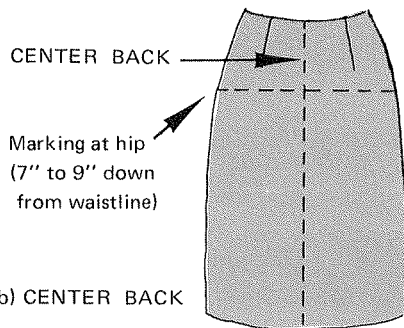

(b) CENTER BACK

ADJUSTMENTS

Take care of standard adjustments, such as shortening or lengthening the waistline, first.

Pin out wrinkles or gaps.

Slash the muslin if it is too tight and add extra length or width as needed.

Alter darts if necessary.

Do not overfit and remove the ease allowed.

AFTER ADJUSTMENTS ARE MADE

Try on the garment again to be sure the alterations have come out all right.

Rip muslin apart. Measure and record adjustments for future use.

Transfer adjustments to the tissue pattern.

Use adjustments for all patterns.

Taper adjustments gradually (Illustration 4) in tissue pattern.

Pin or baste tissue paper under the pattern where an increase is needed. Fold the pattern into a tuck where a decrease is needed.

Check the basic muslin yearly to see if your figure has changed.

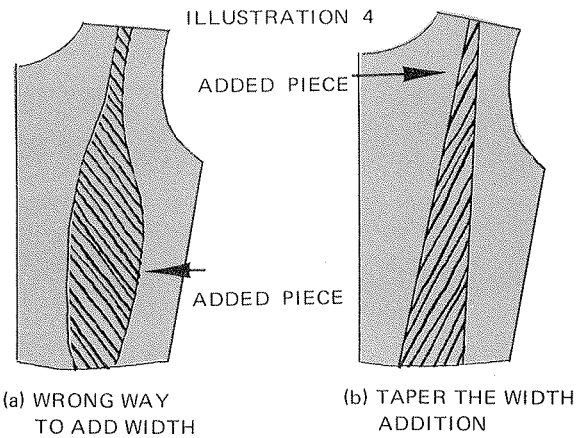

THE TRIAL MUSLIN FOR A SUIT OR COAT

The trial muslin suit or coat fulfills the same purpose as the basic garment with several other important reasons.

More intricate design features are involved than in a less tailored garment.

Design features can be adjusted to suit the individual figure.

Practice on new and complicated construction details is allowed.

Alterations can be worked out before cutting into more expensive material.

The skirt is not ordinarily cut unless it has intricate design features or the individual has figure problems.

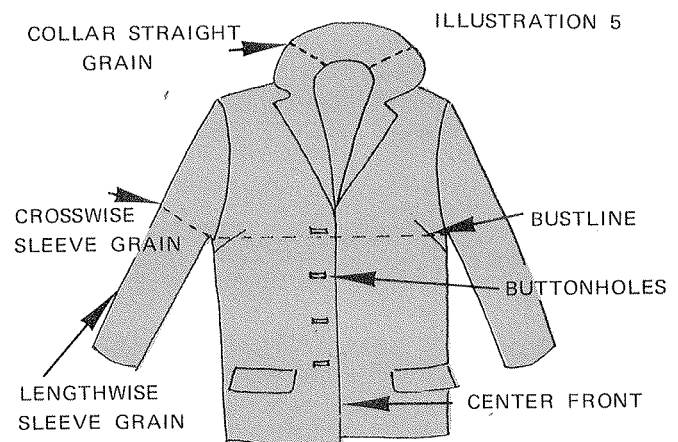

(a) SUIT OR COAT FRONT

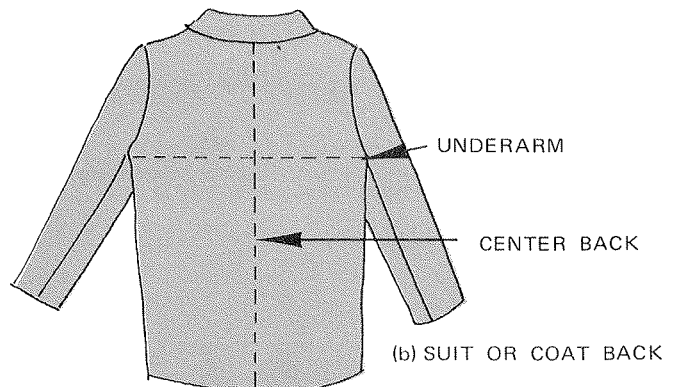

(b) SUIT OR COAT BACK