

University of Nebraska - Lincoln

DigitalCommons@University of Nebraska - Lincoln

Faculty Publications in Food Science and
Technology

Food Science and Technology Department

1995

Global Regulation of a σ^{54} -Dependent Flagellar Gene Family in *Caulobacter crescentus* by the Transcriptional Activator FlbD

Jianguo Wu
Princeton University

Andrew K. Benson
University of Nebraska-Lincoln, abenson1@unl.edu

Austin Newton
Princeton University

Follow this and additional works at: <http://digitalcommons.unl.edu/foodsciefacpub>

 Part of the [Food Science Commons](#)

Wu, Jianguo; Benson, Andrew K.; and Newton, Austin, "Global Regulation of a σ^{54} -Dependent Flagellar Gene Family in *Caulobacter crescentus* by the Transcriptional Activator FlbD" (1995). *Faculty Publications in Food Science and Technology*. 86.
<http://digitalcommons.unl.edu/foodsciefacpub/86>

This Article is brought to you for free and open access by the Food Science and Technology Department at DigitalCommons@University of Nebraska - Lincoln. It has been accepted for inclusion in Faculty Publications in Food Science and Technology by an authorized administrator of DigitalCommons@University of Nebraska - Lincoln.

Global Regulation of a σ^{54} -Dependent Flagellar Gene Family in *Caulobacter crescentus* by the Transcriptional Activator FlbD

JIANGUO WU, ANDREW K. BENSON, AND AUSTIN NEWTON*

Department of Molecular Biology, Princeton University, Princeton, New Jersey 08544-1014

Received 17 January 1995/Accepted 31 March 1995

Biosynthesis of the *Caulobacter crescentus* polar flagellum requires the expression of a large number of flagellar (*fla*) genes that are organized in a regulatory hierarchy of four classes (I to IV). The timing of *fla* gene expression in the cell cycle is determined by specialized forms of RNA polymerase and the appearance and/or activation of regulatory proteins. Here we report an investigation of the role of the *C. crescentus* transcriptional regulatory protein FlbD in the activation of σ^{54} -dependent class III and class IV *fla* genes of the hierarchy by reconstituting transcription from these promoters in vitro. Our results demonstrate that transcription from promoters of the class III genes *flbG*, *flgF*, and *flgI* and the class IV gene *fljK* by *Escherichia coli* $E\sigma^{54}$ is activated by FlbD or the mutant protein FlbD^{S140F} (where S140F denotes an S-to-F mutation at position 140), which we show here has a higher potential for transcriptional activation. In vitro studies of the *flbG* promoter have shown previously that transcriptional activation by the FlbD protein requires *flr* (*flr* for flagellar transcription regulation) sequence elements. We have now identified multiple *flr* sequences that are conserved in both sequence and spatial architecture in all known class III and class IV promoters. These newly identified *flr* elements are positioned ca. 100 bp from the transcription start sites of each σ^{54} -dependent *fla* gene promoter, and our studies indicate that they play an important role in controlling the levels of transcription from different class III and class IV promoters. We have also used mutational analysis to show that the *flr* sequences are required for full activation by the FlbD protein both in vitro and in vivo. Thus, our results suggest that FlbD, which is encoded by the class II *flbD* gene, is a global regulator that activates the cell cycle-regulated transcription from all identified σ^{54} -dependent promoters in the *C. crescentus* *fla* gene hierarchy.

The dimorphic bacterium *Caulobacter crescentus* generates two functionally and structurally distinct progeny cells after each cell division: a motile swarmer cell with a single polar flagellum and a sessile stalked cell. The new swarmer cell is formed during division of the stalked cell and requires the sequential assembly of surface structures during the cell cycle at the stalk-distal pole, including a single flagellum. The *C. crescentus* flagellum, like other bacterial flagella, can be divided into three basic parts: the basal body, a short curved structure called the hook, and the external flagellar filament (22). Flagellum biosynthesis requires the activity of ca. 50 flagellar (*fla*) genes that have been assigned to one of four classes (I to IV) arranged in a regulatory hierarchy on the basis of their time of expression in the cell cycle, promoter architecture, and results of epistasis experiments. The flagellum is assembled from the inside of the cell to the outside in the order basal body-hook-flagellar filament, and the sequence of *fla* gene expression in the *C. crescentus* cell cycle reflects this order. Thus, the class II MS-ring and switch protein genes are expressed early, and their expression is required in turn for expression of the class III hook protein gene and of the class IV flagellin genes later in the cell cycle (for reviews, see references 6 and 33).

Flagellum biosynthesis and flagellar gene expression in *C. crescentus* are coupled in some manner to DNA synthesis (41, 50), and more recent results indicate that chromosome replication is required for transcription of the class II genes, which are near the top of the hierarchy (13, 52). The class I genes, although not yet identified, are presumed to encode proteins that respond directly to cell division cycle signals and to be

required in turn for expression of class II genes. Class II genes encode the first components of the flagellar basal body, including proteins for flagellar protein-specific export (13, 44, 45, 62) and regulatory proteins required for the expression of class III and class IV genes (34, 43, 61). Class III genes, which encode the components of the outer basal body and hook, are required for expression of the class IV flagellin genes (11, 12, 18, 29, 40).

Extensive analyses of promoter sequences and genetic and biochemical studies of *fla* gene regulation have shown that *fla* genes at different classes in the genetic hierarchy are transcribed by specialized forms of RNA polymerase. Class II genes contain at least two promoter types, those of class IIA and class IIB. Class IIB genes, including *fljF* (54), *fljQ* (13), *fljL* (52, 62), and *rpoN* (2), share a common promoter consensus that is unlike that of other bacterial promoters and may be recognized by a specialized activator or form of RNA polymerase (3, 45, 52). The sequence of the class IIA promoter of the *flhA* is not similar to the class IIB promoter consensus (44, 48), and it is presumably recognized by another specialized form of RNA polymerase (3, 45).

The class III and class IV *fla* gene promoters at the bottom of the hierarchy have been the most extensively studied. DNA sequence analysis originally indicated that they are σ^{54} -dependent promoters (see Table 1) (9, 26, 28). This conclusion was supported by extensive site-directed mutagenesis of the class III *flbG* and *flgK* promoters, which demonstrated that the conserved sequences and spacing characteristic of this promoter class are absolutely required for their transcription both in vivo (30) and in vitro (36). More recently, it has been demonstrated that the *rpoN* gene, which encodes σ^{54} , is required for class III (2, 7) and class IV (59) *fla* gene expression.

The enteric $E\sigma^{54}$ (σ^{54} -containing RNA polymerase) is unique among prokaryotic RNA polymerase holoenzymes, in that formation of transcription-competent open complexes de-

* Corresponding author. Mailing address: Phone: (609) 258-3854. Fax: (609) 258-6175.

depends on the function of activation proteins that typically bind to specific DNA sequence elements located upstream of the transcriptional start site (for reviews, see references 20 and 23). The *cis*-acting *flr* sequences (*flr* for flagellar transcription regulation) with an apparently similar function were originally identified ca. 100 bp from the transcription start sites of the class III *flbG* and *flgK* promoters and of the class IV *fljK* and *fljL* flagellin promoters (26, 28). The requirement of these sequence elements for transcription from the class III *flbG* and *flgK* genes was subsequently demonstrated both *in vivo* (15, 30, 31) and *in vitro* (3).

Genetic evidence has shown that the *flbD* gene, identified by Ramakrishnan and Newton (43), is essential for transcription of the *fla* genes from σ^{54} -dependent promoters (34, 43). Its predicted product, FlbD, is homologous to NtrC and a family of response regulators known to activate transcription by Eo⁵⁴ in *Escherichia coli*, *Salmonella typhimurium*, *Rhizobium meliloti*, and *Pseudomonas putida* (for reviews, see references 20, 23, and 57). Recent studies of the *flbG* promoter have demonstrated that FlbD is an *flr*-specific DNA-binding protein that contacts symmetrical guanine residues in the *flr1* and *flr1** sequence elements (3, 4). The FlbD protein was also shown to make similar contacts with *flr4* (54), a DNA sequence which overlaps the *fliF* promoter (3). Comparable observations of FlbD binding at *flr* sequences have been made with C-terminal fragments of FlbD containing the helix-turn-helix domain (32) and a poly-His-tagged FlbD derivative (58). By reconstituting transcription *in vitro* with highly purified proteins, work from this laboratory has demonstrated directly that the FlbD protein activates transcription from the class III *flbG* promoter and represses transcription from the class II *fliF* promoter by its interactions with *flr* sequence elements that have previously been shown genetically to be essential for the regulation of *flbG* (*flr1*) and *fliF* (*flr4*) expression (3).

Other conserved sequences, designated RF-2 and RF-3, upstream from class III genes *flgH*, *flgI*, and *flgF* have also been described (6, 11). Although the impact of these putative *cis*-acting sequences on transcription has not been studied in detail, their identification raises the question of whether activation by FlbD at *flr* sequence elements, as described above for *flbG* (3, 4), is necessary and sufficient for regulation of all class III and class IV genes. To address this question, we have extended our studies of *flbG* to other σ^{54} -dependent class III and class IV promoters to determine the requirement of FlbD and *flr* sequences for transcriptional activation. We have found that all class III transcription units described to date and the class IV genes, which encode the 25- and 27-kDa flagellins, contain multiple *flr* sequences that are positioned ca. 100 bp from the transcription start sites. We have also used a reconstituted *in vitro* transcription system containing *E. coli* Eo⁵⁴ to examine in detail the class III *flgI*, *flgF*, and *flbG* promoters and the class IV *fljK* promoter. Our results demonstrate that FlbD activates transcription from each of these promoters and that full activation by FlbD both *in vitro* and *in vivo* requires an intact pair of *flr* sequences. These results lead us to propose that FlbD globally regulates transcription from all σ^{54} -dependent class III and class IV *fla* gene promoters and that its function is mediated by interaction with the *cis*-acting *flr* sequence elements.

MATERIALS AND METHODS

Site-directed mutagenesis of *flbD*. The *flbD* mutation encoding FlbD^{S140F} was constructed with the *SalI*-*SacII* fragment from pGIR132, which encodes the central domain of FlbD from *C. crescentus*. The fragment was ligated into the mutagenesis vector pALTER-1 (Promega) to generate pJW102. It was then mutated by site-directed mutagenesis with the oligonucleotide MJW-1: CCAG

GTCGCCCTTCGAAGCCTCG. This changed the codon for Ser-140 to a codon for phenylalanine and introduced a *Bst*BI site to the resultant plasmid pMJW1.

Construction of vector for protein expression. The wild-type FlbD protein was overexpressed in *E. coli* by using plasmid pGIR168 as described previously (3, 4). pGIR168 is a derivative of pAR3039/pET3-b in which a 2-kb *Bam*HI-*Eco*RV fragment containing the entire *flbD* gene is fused transcriptionally to the gene 10 promoter of bacteriophage T7.

The plasmid used for overproduction of the mutant FlbD, FlbD^{S140F}, was constructed as follows. The *Nco*I fragment of pGIR168 containing the wild-type *flbD* gene was replaced by the *Nco*I fragment from pMJW1 containing the S140F mutation. The resultant plasmid, pJW201, like pGIR168, contains the entire *flbD* gene on a 2-kb *Bam*HI-*Eco*RV fragment that was fused transcriptionally to the gene 10 promoter of bacteriophage T7.

Protein overexpression and purification. Plasmids pGIR168 and pJW201 were transformed separately into *E. coli* BL21 (DE3) to overproduce the FlbD^{WT} (WT, wild type) and FlbD^{S140F} (S140F denotes an S-to-F mutation at position 140) proteins, respectively. Cells were grown in ML-Amp100 liquid medium at 37°C overnight. Four liters of fresh medium was inoculated with 40 ml of the overnight cultures and then incubated at 37°C. When the optical density at 600 nm reached ca. 1.0, the cultures were induced to overproduce proteins with IPTG (isopropyl- β -D-thiogalactopyranoside) to a final concentration of 1 mM. The cells were harvested and washed with TE buffer (10 mM Tris [pH 8.0], 1 mM EDTA). The proteins were purified as described previously (3). This procedure yielded FlbD protein that was greater than 95% pure, as judged by Coomassie blue staining of sodium dodecyl sulfate-polyacrylamide gels. The purified protein was dialyzed against TGED (20 mM Tris [pH 7.9], 5% glycerol, 0.1 mM EDTA, 0.1 mM dithiothreitol) in 50% glycerol and stored at -80°C.

Mutation of *flr5*, *flr5, and *flr5***.** A 280-bp *Eco*RI fragment which contains the *flgF* promoter region was generated by PCR and introduced into the *Eco*RI site of pBluescript II to yield pAKC26. The identification and orientation of the insert were verified by dideoxy sequencing. The 280-bp *flgF* from pAKC26 was cloned as a *Bam*HI-*Hind*III fragment into the *Bam*HI-*Hind*III sites of the mutagenesis vector pALTER-1 to yield pAKC27. It was then mutated by site-directed mutagenesis with the following three oligonucleotides: (i) FTR5-A, AATCTGCCCGTCAGAGTCCG, which makes a transversion from G to T at position -92 of *flr5* to yield pJWMF1; (ii) FTR5-B, TGGTCCGAGTCTGAA TCTGC, introducing the transversion from G to T at position -106 of *flr5** to yield pJWMF2; and (iii) FTR5-C, TTTTGCCGGTCAATTGGTCCG, introducing the transversion from G to T at position -120 of *flr5*** to yield pJWMF3. The presence of mutations was confirmed by dideoxy sequencing.

***flr7* and *flr7** mutations.** The *fljK* promoter was isolated from a 1.1-kb *Eco*RI fragment derived from pCN200 (27) and was inserted into the *Eco*RI site of pUC18, to generate pAKC7. Then the 520-bp *Pst*I fragment of pAKC7 was subcloned into the *Pst*I site of the mutagenesis vector pALTER-1, to yield pAKC12. The orientation of the insert was confirmed by restriction enzyme digestion. It was then mutated by site-directed mutagenesis to make single nucleotide changes with the following oligonucleotides: FTR7-A, AGGCTC TCGTCAGAAATTGC, which introduces a transversion from G to T at position -101 of *flr7* to yield pJWMK1; FTR7-B, AGAAATTGCTGGGAGCCTTC, which makes a transition from G to A at position -112 of *flr7* to generate pJWMK2; and FTR7-A*, CAGATAGTCCGTCACAATTCCCA, which introduces a transversion from G to T at position -140 of *flr7** to produce pJWMK3. The mutations were verified by dideoxy sequencing.

Construction of templates for transcription assays. All plasmids used for *in vitro* transcription assays in this study were derived from plasmid pTE103, which contains the pUC8 multiple cloning sites that are positioned 215 bp upstream of a strong *rho*-independent transcription terminator of bacteriophage T7 (14).

(i) *flbG* promoter. The plasmid pNJ5 (3, 4, 36) carries a 650-bp *Hind*III-*Eco*RI fragment containing the *flbG* promoter cloned into the *Hind*III and *Eco*RI sites of pTE103. The transcriptional start site for the *flbG* operon is positioned 365 bp upstream from the T7 terminator (36) (see Fig. 3).

(ii) *flgF* promoter and mutant *flr* elements. A 280-bp *Bam*HI-*Hind*III fragment containing the *flgF* promoter and its wild-type *flr* elements from pAKC27 was subcloned into the *Bam*HI and *Hind*III sites of pTE103, to generate pAKC28. In pAKC28, the transcription initiation site of *flgF* is located 336 bp upstream of the T7 termination site. The *Bam*HI-*Hind*III fragments containing mutant *flr5*, *flr5**, or *flr5*** sequences were constructed from plasmids pJWMF1, pJWMF2, and pJWMF3 by subcloning 280-bp *Bam*HI-*Hind*III fragments into the *Bam*HI-*Hind*III sites of pTE103, to generate plasmids pJWF1, pJWF2, and pJWF3, respectively. In these three plasmids, as in pAKC28, the *flgF* transcriptional initiation sites are positioned 336 bp upstream of the T7 terminator (see Fig. 3 and 4).

(iii) *fljK* promoter and mutant *flr* elements. Plasmid pAKC8 was constructed by insertion of the 520-bp *Pst*I fragment of pAKC7 containing the *fljK* promoter into the *Pst*I site of pTE103. The orientation of the insert was confirmed by digestion with the restriction enzyme *Eco*RI. Plasmids containing the mutant *flr7* or *flr7** site were constructed by insertion of the *Pst*I fragments from pJWMK1, pJWMK2, and pJWMK3 into pTE103, to generate pJWK1, pJWK2, and pJWK3, respectively. In pAKC8, as well as in pJWK1, pJWK2, and pJWK3, the *fljK* transcriptional start site lies 451 bp upstream of the T7 termination site (see Fig. 3 and 5).

(iv) *flgI* promoter. pAKC30 was constructed as follows. A 310-bp *EcoRI* fragment containing the *flgI* promoter region was generated by PCR and cloned into the *EcoRI* site of pBluescript II, to yield the plasmid pAKC29. The identification and orientation of the insert were confirmed by dideoxy sequencing. The *BamHI-HindIII* fragment from pAKC29 was subcloned into the *BamHI* and *HindIII* sites of pTE103, to generate pAKC30. In pAKC30, the *flgI* transcriptional initiation site was placed 368 bp upstream of the T7 terminator (see Fig. 3).

Transcription assays. The formation of heparin-resistant open complexes at the σ^{54} -dependent promoters was measured in single-cycle transcription assays as described previously (3, 4, 37). The transcription assay was performed at 34°C in a total volume of 50 μ l in transcription buffer containing 50 mM Tris-HCl (pH 7.8), 100 mM NaCl, 1 mM dithiothreitol, 200 μ g of bovine serum albumin per ml, 0.1 mM EDTA, and 10 mM MgCl₂. Purified reagents were added to the final concentrations indicated as follows: *E. coli* core RNA polymerase (100 nM), *E. coli* σ^{54} (200 nM), NtrC (400 nM), NtrB (160 nM), and supercoiled plasmid template (5 nM). The concentrations of the FlbD^{WT} and FlbD^{S140F} proteins were varied as indicated in individual experiments. End-labeled *Sau3A* fragments of pUC18 were used as DNA size markers.

Construction of *fla* promoter-*lacZ* fusions. The *lacZ* reporter gene fusions were constructed by subcloning *fla* gene promoters into pANZ5 (38), which contains a promoterless *lacZ* reporter gene in a plasmid capable of autonomous replication in *C. crescentus*. DNA fragments containing the *flgF* promoter region with wild-type *ftr* elements or with mutant *ftr5*, *ftr5**, or *ftr5*** were subcloned into the *KpnI* and *XbaI* sites of pANZ5, to generate transcriptional fusion vectors pJWFZ, pJWF1Z, pJWF2Z, and pJWF3Z, respectively. The *fliK* promoter was subcloned as a *PstI* fragment from pAKC8 into the *PstI* site of pANZ3, to yield the *fliKp-lacZ* fusion plasmid pJWKZ. The promoter fragment and construction of the *flbGp-lacZ* fusion plasmid pANZ405 have been described previously (34). A *KpnI-XbaI* fragment containing the *flgI* gene promoter from plasmid pAKC30 was subcloned into the *KpnI* and *XbaI* sites of pANZ5, to yield the *flgIp-lacZ* fusion plasmid pJWIZ.

β -Galactosidase activity assays. *C. crescentus* strains containing *fla* promoter-*lacZ* fusion plasmids were grown to mid-logarithmic phase (optical density at 600 nm, 0.3 to 0.7) in PYE medium (40). Assays of β -galactosidase activity were performed according to the method of Miller (24).

Construction of *fla* promoter-*xyIE* fusions. Wild-type and *ftr*-mutant *fliK* promoter fragments were fused transcriptionally to a promoterless *xyIE* reporter gene by cloning the *PstI-SalI* fragments from the wild-type pAKC8 and from mutants pJWK1, pJWK2, and pJWK3 into the *PstI-XhoI* sites of plasmid pRKX-1. This created plasmids pAKC81 (wild type), pAKC84 (*ftr7* [C101T]), pAKC85 (*ftr7* [G112A]), and pAKC86 (*ftr7** [G140T]), respectively. The parental pRKX-1 plasmid carries a 1.5-kb DNA fragment containing the *xyIE* gene (19) that was inserted into the unique *BamHI* site of pRK2L10.

XyIE activity assays. XyIE activity was measured in cell extracts prepared from logarithmically growing cells. Cells were grown in M2 minimal medium (40), harvested by centrifugation, resuspended in 50 mM potassium phosphate buffer, pH 7.5, containing 100 mM KCl, and lysed by passage through a French pressure cell. Cellular debris was removed by centrifugation, and the extracts were assayed for protein concentration with the Bio-Rad protein assay kit. Assays were performed on equal amounts of protein at 30°C as described by Konyecsni and Deretic (19).

RESULTS

Organization of *ftr* sequences in class III and class IV *fla* genes. Recent *in vitro* transcription results have shown that the *C. crescentus* FlbD protein, which is homologous to the NtrC family of bacterial response regulators (43), can activate the transcription of the σ^{54} -dependent class III *flbG* promoter *in vitro* and that this activity depends on intact sequence elements *ftr1* (3, 4) and *ftr1** (3a). To determine if other σ^{54} -dependent *fla* genes contain a similar regulatory architecture, we examined the σ^{54} -dependent promoters of the seven class III and class IV *fla* genes which have been described in *C. crescentus* and found that each of them contains a pair of 19-bp *ftr* sequence elements that align with the FlbD binding sites *ftr1* and *ftr1** of the *flbG* operon and *ftr4* of the *fliF* operon (Table 1). The only exception to this observation is *flgF*, which contains three *ftr* sequence elements. All of the sequences contain the symmetrically placed guanine residues (Table 1, underlined bases) that in *ftr1*, *ftr1**, and *ftr4* are specifically contacted by the full-length FlbD protein (3, 4). The consensus sequence of the symmetrical 19-bp *ftr*, which is CCCGGCARNRNYTGC CGGG, agrees well with that, published previously, based on fewer sequences (3, 54).

It is interesting to note that the *ftr* elements are almost always present in pairs approximately 100 bp upstream of transcriptional start sites, except in *flgK*, where the elements are ca. 100 bp downstream of the start site (15, 30, 31). The exact spacing between centers of adjacent *ftr* sites varies from promoter to promoter and ranges from 33 to 34 bp for the *flbG* and *flgI* promoters to 12 to 15 bp for the *fliL* and *flgH* promoters (Table 1). The possible significance of these differences in spacing is considered in the Discussion.

Activation of transcription *in vitro* by FlbD^{WT} and FlbD^{S140F}. Purified wild-type FlbD activates transcription *in vitro* from the *flbG* promoter at relatively high concentrations without obvious phosphorylation of the purified protein (3). This is in contrast to the well-characterized NtrC protein, whose activity absolutely requires phosphorylation of a conserved aspartate residue near its amino terminus (55). Although there is evidence that FlbD can be phosphorylated (59), a cognate histidine protein kinase has not been identified. Therefore, to facilitate our *in vitro* studies we examined a mutant FlbD (FlbD^{S140F}) to determine if it is a more efficient transcription activator than the wild-type protein. FlbD^{S140F}, which has been used previously in *in vivo* studies of transcription (59), corresponds to one of the well-characterized NtrC-(Con) mutant proteins, NtrC^{S160F}, that is known to partially bypass the requirement for phosphorylation in the *E. coli* system (Fig. 1) (55).

We first compared the capacities of FlbD^{WT} and FlbD^{S140F} to activate transcription from the class III *flgF* operon (rod and L-ring protein genes) and the class IV *fliK* gene (25-kDa flagellin protein gene) promoters which contain the *ftr* sequences shown in Table 1. The *flgF* gene transcription start site in the supercoiled plasmid template pAKC28 lies 336 bp upstream of the T7 *rho*-independent terminator of the parental plasmid pTE103. The addition of FlbD (Fig. 2A) produced a transcript that migrated very close to the expected position of a 336-nucleotide transcript predicted from the *in vivo* mapped start site (51). When FlbD^{S140F} was substituted for FlbD^{WT}, the same-size transcript was observed, but with a much stronger signal, and transcription was detected at FlbD^{S140F} concentrations as low as 40 nM. In contrast, concentrations of FlbD^{WT} in excess of 240 nM were required for an equivalent signal. To quantify these results, we compared the band intensities of FlbD^{WT}- and FlbD^{S140F}-dependent transcripts for each of the different concentrations tested. Results of PhosphorImage analysis showed that the level of *flgF*-specific transcript activated by FlbD^{S140F} is 14- to 16-fold higher than that by its wild-type counterpart, FlbD^{WT}, at each concentration examined. Thus, as predicted from the homology to NtrC^{S160F}, the FlbD^{S140F} protein has a greater capacity to catalyze open complex formation by $\text{E}\sigma^{54}$ than wild-type FlbD in the absence of any modification.

We also examined the class IV *fliK* promoter for activation by FlbD^{WT} and FlbD^{S140F} (Fig. 2B). When FlbD was added to the reaction mixtures containing the *fliK* promoter template, an RNA of the size expected from the previously mapped *in vivo* start site (451 nucleotides) (26) was observed in all the reaction mixtures, even at an FlbD^{WT} or FlbD^{S140F} concentration as low as 40 nM. The levels of transcript increased as the concentrations of the FlbD^{WT} or FlbD^{S140F} protein were increased, and as observed above for the *flgF* promoter, FlbD^{S140F} was a more effective transcription activator than FlbD^{WT}. Quantification of these results by PhosphorImage analysis as described above showed that FlbD^{S140F} generated about fivefold-more transcript than FlbD^{WT} at each protein concentration. Thus, the S140F substitution in FlbD increased the capacity of the protein to activate transcription from both

TABLE 1. Alignment of *ftr* sequence elements and σ^{54} -dependent promoters of *C. crescentus fla* genes

Class	Gene	<i>ftr</i>	Spacing ^a	Position ^b	<i>ftr</i> sequence ^c	σ^{54} -dependent promoter ^d	Reference(s)
IIB	<i>fliF</i>	<i>ftr4</i>	7	-16	GTGGGTAATCTG <u>CC</u> TAC	NA ^e	22, 52
III	<i>flbG</i>	<i>ftr1</i>	3	-117	CTCGGC ^c AAAAAGCG <u>CCG</u> CAC	TGGCCCGACCGT <u>TGC</u>	23
		<i>ftr1</i> *		-150	CGCGGC ^c AACTCCCGT <u>CC</u> CT		
III	<i>flgK</i>	<i>ftr2</i>	4.5	+59	CCCGGC ^c AAGTTTC <u>CGCCG</u> GG	TGGCGCCGACCT <u>TGC</u>	25
		<i>ftr3</i>		+100	CGCGGTTTGCCGAG <u>CCG</u> GAA		
III	<i>flgF</i>	<i>ftr5</i>	2.5	-96	CCCGGC ^c AGAGTCCGAC <u>CAG</u>	TGGCACGAAGGT <u>TGC</u>	9
		<i>ftr5</i> *		-110	GCAGGC ^c TGAATCTG <u>CCCG</u> G		
		<i>ftr5</i> **		-124	CCGGGC ^c AATTGGT <u>CGCAG</u> G		
III	<i>flgI</i>	<i>ftr6</i>	3	-81	CCCGGC ^c CTTGTCGGAAATC	TGGCCCGCTTCT <u>TGC</u>	15
		<i>ftr6</i> *		-115	CGGGC ^c AGAATCTG <u>CCGTG</u>		
III	<i>flgH</i>	<i>ftr9</i>	1.5	-135	CATGGCCCGCCGCG <u>CCG</u> CC	AGGCCCAGAGCT <u>TGC</u>	9
		<i>ftr9</i> *		-147	CAAGGC ^c CATGGCCG <u>CCG</u> CC		
IV	<i>fljK</i>	<i>ftr7</i>	2.5	-116	CTCGGC ^c CAGAAATG <u>CCGGG</u>	TGGCCCGGCAAT <u>TGC</u>	20
		<i>ftr7</i> *		-145	GCCGGC ^c CAACAATTT <u>CC</u> CAT		
IV	<i>fljL</i>	<i>ftr8</i>	1.5	-130	CCCGGC ^c GTAAGTTG <u>CAT</u> TC	TGGCCCGCGCT <u>TGC</u>	20, 45
		<i>ftr8</i> *		-147	TCTGGAAAAGCTG <u>CCG</u> CC		
Consensus ^f					CCCGGC ^c ARNRNYT <u>CCGGG</u> GGCCGTYNRRACGGCC	TGGCCCN ⁿ NNNT <u>TGC</u>	

^a Number of helical turns from centers of a pair of *ftr* sequences.

^b Measured from +1 to edge of *ftr* sequence.

^c Nucleotides which match those in the consensus sequence are shown in boldface type; underlined nucleotides are potential FlbD contact sites, homologous to those found in *ftr1*, *ftr1**, and *ftr4* (3).

^d Nucleotides which match those in the σ^{54} -dependent promoter consensus are shown in boldface type; underlined nucleotides indicate the -12 and -24 sites of σ^{54} -dependent promoter.

^e NA, not applicable.

^f R, purines; Y, pyrimidines; N, any bases. Contact sites between *flbD* and guanine residues of *ftr1*, *ftr1**, and *ftr4* are underlined in the consensus sequence (3, 4).

the *flgF* and the *fljK* promoters and permitted the use of much lower protein concentrations to generate strong transcription signals in our assays. Consequently, we used the mutant FlbD^{S140F} protein in all the in vitro transcription assays described below.

Comparison of the activity of FlbD on σ^{54} -dependent *fla* gene promoters. To investigate the role of FlbD-*ftr* interactions in the regulation of the class III and class IV *fla* genes analyzed in Table 1, we compared transcription in vitro from the σ^{54} -dependent promoters of *fljK* (25-kDa flagellin), *flgF* (rod and L-ring proteins), *flbG* (hook components), and *flgI* (P-ring and basal body components). Of these, only the *flbG* promoter has been examined in vitro previously. The structures of the promoters and regulatory elements are diagrammed in Fig. 3A.

Transcripts were not detected from reaction mixtures containing any of the four templates when the FlbD^{S140F} protein was absent (Fig. 3B; lanes 1, 5, 9, and 13). The addition of 100 nM FlbD^{S140F} activator protein in the reaction mixtures containing plasmids pAKC8 (*fljK*; Fig. 3B, lane 2), pAKC28 (*flgF*; Fig. 3B, lane 6), pNJ5 (*flbG*; Fig. 3B, lane 10), and pAKC30 (*flgI*; Fig. 3B, lane 14) resulted in the formation of transcripts with expected sizes of 451, 336, 365, and 368 nucleotides, respectively, which are based either on in vivo transcription start site mapping (11, 26) or, in the case of *flgI*, on the location of the σ^{54} -dependent promoter (18). Although the abundance of the transcripts generated from these promoters was low at 100 nM FlbD^{S140F}, the levels were substantially increased with the addition of more activator protein (Fig. 3B). However, the

efficiency of transcription from the promoters examined differed widely, with the class IV *fljK* promoter being the most efficient and the class III *flgI* promoter being the least efficient under our assay conditions, as judged by visual inspection of the autoradiograms in Fig. 3. We consider possible mechanisms that affect levels of transcription in the experiments described below.

We have extended this in vitro analysis to examine the requirement of *flbD* in vivo. Each of the four promoters was fused to a promoterless β -galactosidase gene present in the plasmid pANZ5 (see Materials and Methods). The expression of β -galactosidase from these fusions was then determined in a wild-type strain (CB15) and an *flbD*::Tn5 mutant strain (PC5510). In each case, transcription was abolished or severely depressed in the *flbD* mutant strain (Table 2). Previous studies of *flbG* (39), *flgF* (11), and *fljK* (58) transcription in vivo have yielded similar results and support the in vitro results presented in Fig. 3, which indicate that FlbD directly mediates transcriptional activation of these promoters. We also noted the same rank order in levels of FlbD-mediated expression from this set of σ^{54} -dependent promoters assayed in vitro and in vivo, but the relative difference between levels of transcription from the promoters was less when assayed in vivo.

Requirement of *ftr* sequences for *flgF* and *fljK* transcription. The *ftr* sequence elements identified in Table 1 are located upstream of the σ^{54} -dependent *fla* promoters in the same relative position as are *ftr1* and *ftr1** in the *flbG* promoters (3, 32). To determine the requirement of these sequences for pro-

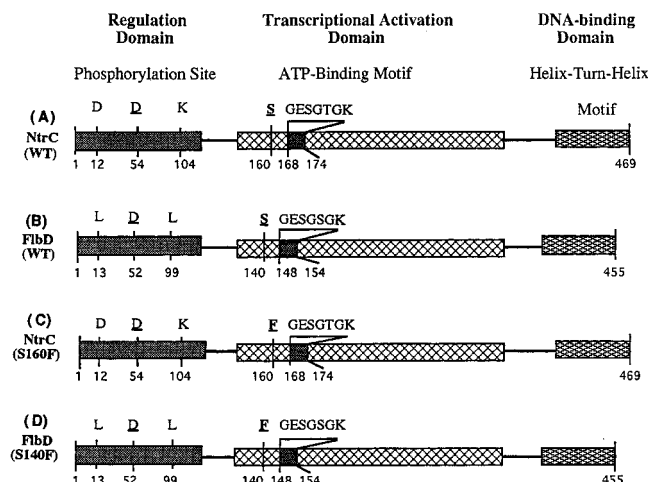

FIG. 1. Comparison of potential function domains of FlbD with NtrC. (A) The *S. typhimurium* wild-type NtrC contains 469 amino acids and consists of three functional domains. The regulatory domain (about 120 amino acids), which is located at the amino terminus, contains three amino acids (indicated by the one-letter amino acid code) that are signatures of the response regulator class of proteins and typically forms an acid pocket around the site of phosphorylation in the CheY crystal structure (53). The transcriptional activation domain (about 240 amino acids), which is located in the central portion of the protein, contains an ATP-binding motif. (The sequence shown for the NtrC protein is taken from the corrected sequence reported by Weiss et al. [56].) The DNA-binding domain (about 60 amino acids), which is located at the carboxyl terminus of the protein, contains a putative helix-turn-helix motif. Phosphorylation of NtrC is absolutely required for the activity of this protein. (B) The *C. crescentus* wild-type FlbD contains 455 amino acids and has a structure homologous to that of NtrC, with the exception that only one of the three most highly conserved amino acids is present in the regulatory domain of FlbD. (C) The structure of a mutant NtrC protein, NtrC^{S160F}. In this protein, the serine residue at position 160 has been replaced by a phenylalanine residue. This protein, unlike its wild-type counterpart, has a weak capacity for transcriptional activation without phosphorylation. (D) The structure of the mutant FlbD protein, FlbD^{S140F}, which has been used in this study. In FlbD^{S140F}, the serine residue at position 140 has been replaced by a phenylalanine residue, corresponding to the substitution made in NtrC^{S160F}.

motor activation, we constructed a series of plasmids containing mutations at highly conserved positions within the *ftr* sequences. Dimethyl sulfate footprinting assays have shown that FlbD makes base-specific contacts at highly conserved guanine residues in each half site of the *ftr* sequences (Table 1) (3). Consequently, five of the mutations in *ftr* elements made in this study were G-to-T transversions and one was a G-to-A transition at these conserved positions.

The levels of transcripts from supercoiled templates containing the *flgF* promoter with the G-to-T transversion at position -92 of *ftr5* (pJWF1), position -106 of *ftr5** (pJWF2), or position -120 of *ftr5*** (pJWF3) were significantly reduced compared with those from the wild-type *flgF* promoter (pAKC28) (Fig. 4). Although transcription was activated from all four templates by FlbD^{S140F} at concentrations of 100 nM or higher, visual inspection of the band intensities revealed that the levels of *flgF*-specific transcripts derived from the mutant templates were lower than those derived from the wild-type template at any given FlbD concentration. In the mutant templates carrying only a single point mutation, we observed residual levels of transcription, e.g., pJWF1 (*ftr5*), pJWF2 (*ftr5**), and pJWF3 (*ftr5***). These activities could be due to the interaction of FlbD^{S140F} with the two remaining intact *ftr* elements. Alternatively, the FlbD^{S140F} protein may still recognize and bind to the mutant *ftr*, but with lowered affinity. Irrespective of the explanation, these results clearly indicate that full activation by FlbD

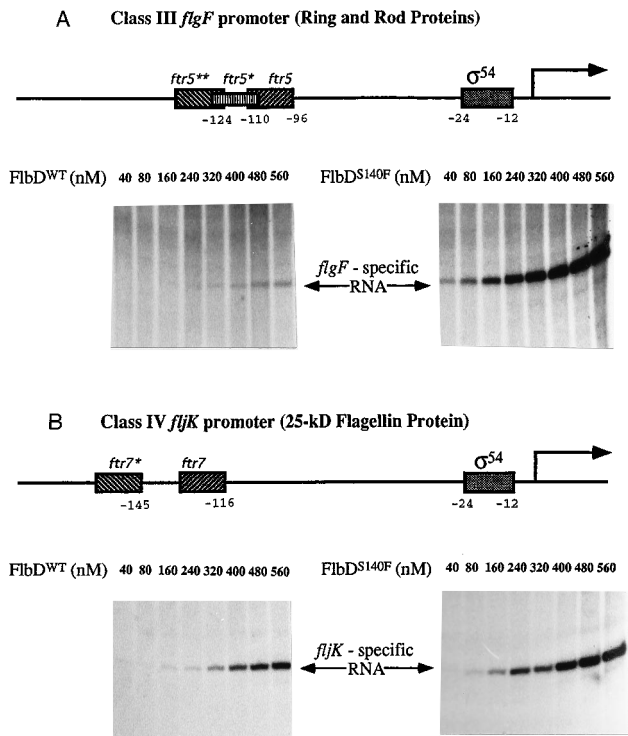
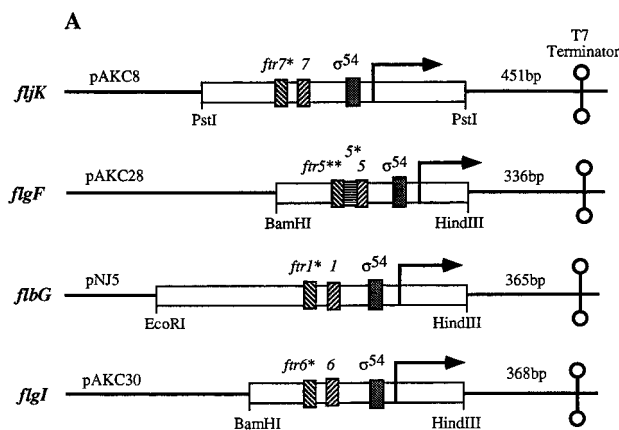

FIG. 2. Analysis of the activities of FlbD^{WT} and FlbD^{S140F}. Drawings of the templates used for this study are shown. Plasmid pAKC28 contains the *flgF* gene promoter in which the start site was placed 366 bp upstream of the *rho*-independent terminator site. Plasmid pAKC8 contains the *fljK* gene promoter in which the transcriptional initiation site was inserted 451 bp upstream of the termination site. The arrows indicate the positions of transcriptional initiation sites and the orientations of the transcripts. The σ^{54} -dependent promoters and *ftr* elements are indicated by boxes. Transcription from the class III *flgF* gene promoter (A) and from the class IV *fljK* gene promoter (B) was activated by FlbD proteins. All transcription reaction mixtures contained 5 nM supercoiled template (pAKC28 [A] or pAKC8 [B]), 100 nM *E. coli* RNA polymerase core enzyme, and 200 nM *E. coli* σ^{54} . The concentrations of the FlbD^{WT} and FlbD^{S140F} proteins are indicated above the lanes. The positions of *flgF*- and *fljK*-specific transcripts on the gels are indicated by arrows.

requires intact *ftr* elements upstream of the σ^{54} -dependent *flgF* promoter.

We also examined the effect of mutations in the *ftr7* and *ftr7** sequence elements on transcription from the class IV *fljK* promoter in plasmids pJWK1 (C to T at position -101 of *ftr7*), pJWK2 (G to A at position -112 of *ftr7*), and pJWK3 (G to T at position -140 of *ftr7**) (see Materials and Methods). Each of these *ftr* mutations (Fig. 5) dramatically reduced the levels of transcription from the *fljK* promoter compared with the template containing wild-type *ftr* elements (Fig. 5). On the basis of the intensity of the labeled bands, the levels of transcripts generated from the mutant *ftr7* and *ftr7** templates were severalfold lower than those generated from the wild-type template. This contrasts with the more modest effect of *ftr* mutations in the *flgF* promoter discussed above (Fig. 4), but it confirms that result by demonstrating that intact, multiple *ftr* sequence elements are also required for full activation of the *fljK* promoter.

We have noted that the level of transcript made from the wild-type *fljK* template pAKC8 was strongly concentration dependent at FlbD^{S140F} concentrations of from 100 to 400 nM. The concentration dependency was, however, much less marked in transcription from mutant templates with altered *ftr* elements (pJWK1, pJWK2, and pJWK3) over the same range



B

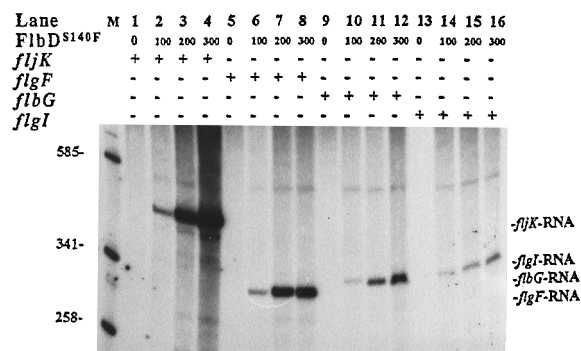

FIG. 3. Transcriptional activation of *fla* gene promoters by FlbD^{S140F} protein. (A) Drawings of the structures of the transcription templates containing the *fljK* (pAKC8), *flgF* (pAKC28), *flbG* (pNJ5), and *flgI* (pAKC30) gene promoters used in this study are shown. Horizontal lines represent the sequences of the vectors. Open boxes indicate the sequences of *fla* genes. Filled boxes indicate the arrangement of the *flr* sequence elements and σ^{54} -dependent promoter sequences. The *rho*-independent terminator is also indicated. The number of base pairs indicates the distance between transcriptional start site and termination site. The orientations of the transcripts are indicated by arrows. (B) Single-cycle transcription assays were performed with 5 nM supercoiled plasmids pAKC8 (lanes 1 to 4), pAKC28 (lanes 5 to 8), pNJ5 (lanes 9 to 12), and pAKC30 (lanes 13 to 16). Each reaction mixture contained 100 nM *E. coli* RNA polymerase core enzyme and 200 nM *E. coli* σ^{54} . The concentrations (nanomolar) of FlbD^{S140F} are indicated above the lanes. Labeled size standards (lane M; in base pairs [shown on the left]) were derived from *Sau3A*-digested pUC18.

of FlbD^{S140F} concentrations. As considered in the Discussion, the mutant *flr* sequences may impair cooperative binding by the FlbD^{S140F} protein.

The results obtained from the *in vitro* experiments described above were confirmed by examining the effects of these *flr* element mutations on activation of transcription from *flgFp-lacZ* fusions (Table 3) and *fljKp-xyE* fusions (Table 4) *in vivo*. Transcription from the *flgF* promoter was substantially reduced in all *flgFp-lacZ* fusions containing *flr* mutations, and the levels of *lacZ* expression were further decreased in the *flbD::Tn5* genetic background (Table 3). We observed similar effects of *flr* mutations on transcription from the *fljKp-xyE* fusions: levels of *xyE* expression were significantly reduced in the three constructs containing mutated *flr* sequences (Table 4). These results further indicate that intact pairs of *flr* sequence elements are required for the full activation of transcription from both class III and class IV gene promoters by FlbD.

TABLE 2. Requirement of *flbD* and *flr* sequences for expression from class III and class IV promoters

Strain	Genotype	Promoter fusion	<i>lacZ</i> expression ^a
PC9971	Wild type	<i>fljKp-lacZ</i>	368
PC9972	<i>flbD::Tn5</i>	<i>fljKp-lacZ</i>	12
PC9906	Wild type	<i>flgFp-lacZ</i>	173
PC9910	<i>flbD::Tn5</i>	<i>flgFp-lacZ</i>	8
PC9918	Wild type	<i>flbGp-lacZ</i>	177
PC9923	<i>flbD::Tn5</i>	<i>flbGp-lacZ</i>	5
PC9915	Wild type	<i>flgIp-lacZ</i>	77
PC9920	<i>flbD::Tn5</i>	<i>flgIp-lacZ</i>	7

^a Data are Miller units, corrected for vector (pANZ5) activity of 34 Miller units.

Role of *flr* elements in the control of transcriptional efficiency.

The efficiency of transcription initiation from the four promoters examined in Fig. 3 varied in the order *fljK* > *flgF* > *flbG* > *flgI* under the conditions we tested. Possible explanations for these differences include the effectiveness of the RNA polymerase-promoter recognition and FlbD-*flr* binding. To evaluate the contribution of these interactions, we first compared the capacities of NtrC (in the presence of the histidine kinase NtrB), whose activity should be independent of specific DNA binding, and of FlbD^{S140F} to catalyze open complex formation at the *fljK* and *flgF* promoters. As shown in Fig. 6 (lanes 5 and 6), we identified conditions in which NtrC and FlbD^{S140F} were approximately equivalent in activating transcription from the *fljK* promoter. The fact that FlbD^{S140F} is much less efficient at stimulating open complex formation from the *flgF* promoter than was NtrC under the same reaction

Class III *flgF* promoter (Ring and Rod Proteins)

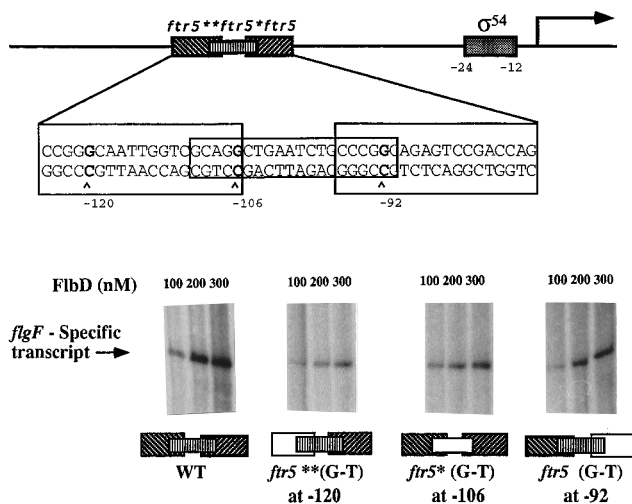

FIG. 4. Effects of *flr* mutations upon activation of transcription from class III *flgF* promoter by FlbD^{S140F} protein. Shown are the structures of the class III *flgF* gene promoter and the *flr5*, *flr5** and *flr5*** sequence elements. All symbols are as described in the legend to Fig. 3. The positions of the nucleotides (in boldface type) that are mutated are indicated. Single-cycle transcription assays were carried out by using 5 nM supercoiled templates, including pAKC28 containing the wild-type *flr* sequences, pJWF1 containing a mutant *flr5* (G to T at position -92), pJWF2 containing a mutant *flr5** (G to T at position -106), and pJWF3 containing a mutant *flr5*** (G to T at position -120). The *flgF* promoter in all four constructs was fused 336 bp upstream of the *rho*-independent terminator. Each reaction mixture also contained 100 nM *E. coli* RNA polymerase core enzyme and 200 nM purified σ^{54} -dependent factor. The concentrations (nanomolar) of FlbD^{S140F} protein are indicated above the lanes.

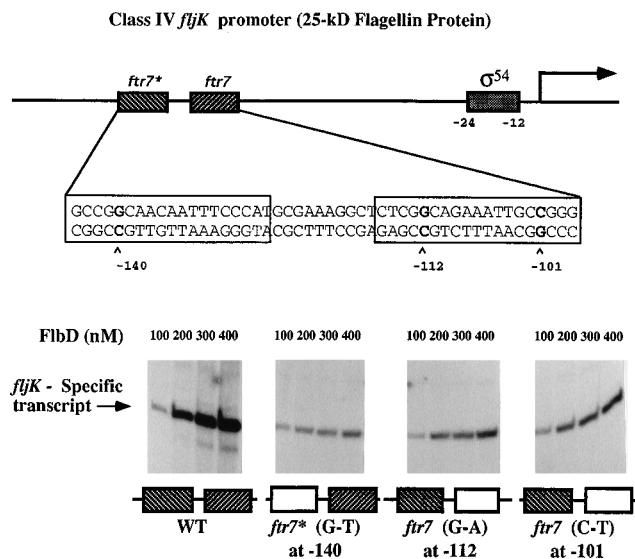

FIG. 5. Effects of mutations in *flr7* and *flr7** on the transcriptional activation from class IV *fljK* gene promoter by FlbD^{S140F}. Shown is the structure of the class IV *fljK* gene promoter and its *flr* elements *flr7* and *flr7**. All symbols are as described in the legend to Fig. 3. The mutated nucleotides are indicated by boldface type. The positions of these nucleotides are indicated by the positions of these nucleotides. Single-cycle transcription assays were performed by using 5 nM supercoiled templates, including pAKC8 containing the *fljK* gene promoter with wild-type *flr7* and *flr7**, pJWK1 containing the *fljK* promoter with a mutant *flr7* (C to T at position -101), pJWK2 containing *fljK* with another mutant *flr7* (G to A at position -112), and pJWK3 containing *fljK* with a mutant *flr7** (G to T at position -140). The *fljK* promoter in all four plasmids was placed 451 bp upstream of the termination site. Each reaction mixture contained 100 nM *E. coli* RNA core polymerase and 200 nM *E. coli* σ^{54} -dependent factor. FlbD^{S140F} concentrations (nanomolar) are indicated over the lanes.

conditions (Fig. 6; lanes 8 and 9) suggests that FlbD^{S140F} is more efficient in activating transcription from the *fljK* promoter than from the *flgF* promoter. These results indicate that the rate of open complex formation at these promoters is limited not by $E\sigma^{54}$ -promoter binding but rather by FlbD-*flr* interaction. The fact that NtrC stimulates nearly equal levels of transcript from both promoters implies that the FlbD^{S140F} concentration is limiting in the reactions with the *flgF* template.

To confirm this conclusion, we carried out identical assays using an equal molar mixture of both the *flgF* and *fljK* promoter templates. The result shows that NtrC generated approximately equal levels of transcripts from each promoter as expected (Fig. 6, lane 2), but when FlbD^{S140F} was present (Fig. 6, lane 3), only the *fljK* transcript was detected. The addition of

TABLE 3. Effect of *flr* mutations on expression of *flgFp-lacZ* promoter fusions

Strain	Genotype	<i>flr</i> ^a	<i>lacZ</i> expression ^b
PC9906	Wild type	Wild type	173
PC9907	Wild type	<i>flr5</i> (G92T)	21
PC9908	Wild type	<i>flr5*</i> (G106T)	32
PC9909	Wild type	<i>flr5**</i> (G120T)	69
PC9910	<i>flbD::Tn5</i>	Wild type	8
PC9911	<i>flbD::Tn5</i>	<i>flr5</i> (G92T)	12
PC9912	<i>flbD::Tn5</i>	<i>flr5*</i> (G106T)	10
PC9913	<i>flbD::Tn5</i>	<i>flr5**</i> (G120T)	9

^a See the legend to Fig. 4.

^b Data are Miller units, corrected for vector (pANZ5) activity of 34 Miller units.

TABLE 4. Effect of *flr* mutations on expression of *fljKp-xylE* promoter fusions

Strain	Genotype	<i>flr</i> ^a	<i>xylE</i> expression ^b
PC1101	Wild type	Wild type	13.68
PC1102	Wild type	<i>flr7</i> (C101T)	0.35
PC1103	Wild type	<i>flr7</i> (G112T)	0.88
PC1104	Wild type	<i>flr7*</i> (G140T)	1.43

^a See the legend to Fig. 5.

^b Specific activities of catechol oxidase in units described previously (19) and corrected for vector activity of 0.31.

both FlbD^{S140F} and NtrC to the reaction mixtures (Fig. 6, lane 4) restored nearly equal levels of transcription from both promoters. If the difference in the levels of transcription between *flgK* and *fljF* (Fig. 6, lanes 6 and 9) were a consequence of interactions of $E\sigma^{54}$ with the respective promoter sequences, we would have predicted that NtrC, which presumably is functioning nonspecifically with the *C. crescentus* promoters, would generate more transcripts from the *fljK* template than from the *flgF* template, as was the case with FlbD^{S140F}. Thus, in our in vitro transcription system, the efficiency of transcription is unlikely to be a consequence of $E\sigma^{54}$ interaction with the respective promoters, and we speculate that the efficiency of FlbD interactions with the respective *flr* binding sites may be a factor governing the efficiency of transcription from the different σ^{54} -dependent *fla* gene promoters.

DISCUSSION

The sequential order of *fla* gene expression in the *C. crescentus* cell cycle is governed, at least in part, by the appearance and/or activation of RNA polymerases containing specialized σ factors, as well as by specific regulatory proteins. In this report, we have examined regulation of the σ^{54} -dependent promoters of class III and class IV *fla* genes. We have found that all of these genes contain multiple *flr* sequence elements

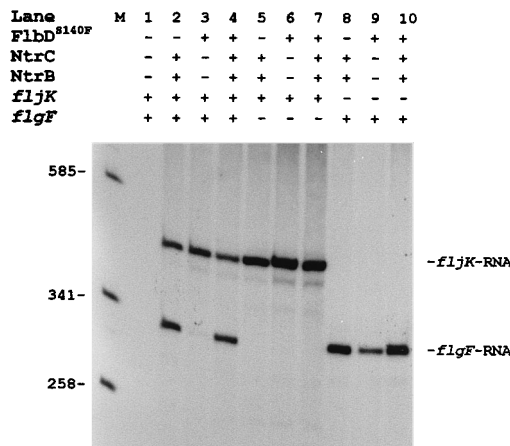

FIG. 6. The role of *flr* sequence elements in determination of the transcriptional efficiency of *fla* gene promoters. Single-cycle transcription assays were performed by using either a mixture of two supercoiled plasmids, pAKC8 containing the class IV *fljK* gene promoter and pAKC28 containing the class III *flgF* gene promoter (lanes 1 to 4), or each of these plasmids alone (pAKC8, lanes 5 to 7, and pAKC28, lanes 8 to 10) (5 nM for each). *E. coli* RNA polymerase core enzyme and σ^{54} -dependent factor were present at final concentrations of 100 and 200 nM, respectively. NtrC, NtrB, and FlbD^{S140F} were added to final concentrations of 400, 160, and 400 nM, respectively. Labeled size standards (lane M; in base pairs [shown on the left]) were derived from *Sau3A*-digested pUC18.

ca. 100 bp from the transcriptional start sites (Table 1). Our results also demonstrate that transcription from class III *flbG*, *flgF*, and *flgI* promoters and the class IV *fljK* promoter is activated by the FlbD protein and that FlbD-dependent transcription requires pairs of intact *ftr* sequence elements in vitro (Fig. 3, 4, and 5) as well as in vivo (Tables 3 and 4). On the basis of these observations, we propose that FlbD functions at *ftr* sequence elements as a global activator of class III and class IV *fla* gene transcription in the *C. crescentus* cell cycle.

FlbD is a transcriptional activator of class III and class IV genes. We have extended our initial studies of FlbD activity on the class III *flbG* promoter (3, 4, 32, 59) by examining the function of FlbD on a wide range of σ^{54} -dependent promoters, including the promoters of the *flgF*, *flgI*, and *flbG* operons at class III and the *fljK* gene at class IV. Our results show (Fig. 3) that purified FlbD is sufficient for the transcriptional activation of each of these promoters. The only identified σ^{54} -dependent class III *fla* gene promoters we have not examined are *flgH* and *flgK*. These promoters also contain pairs of *ftr* sequence elements at ca. 100 bp from the transcription start sites (Table 1), and the *ftr2* and *ftr3* sequence elements of *flgK* are known from previous work to be required in vivo for normal regulation of this *fla* gene (15, 31). We predict that both the *flgK* and *flgH* promoters would be recognized by purified FlbD in our reconstituted $E\sigma^{54}$ transcription system.

Regulation of FlbD activity. The FlbD protein is structurally similar to the NtrC protein (43), whose activity is modulated as a result of phosphorylation by the histidine kinase NtrB in response to nitrogen limitation (17, 35). The *C. crescentus* activator contains three functional domains: the regulatory domain at the amino terminus, the activation domain at the central part, and the DNA-binding domain at the carboxyl terminus (Fig. 1). In NtrC, the phosphorylation site is within an amino-terminal domain of ca. 120 residues (Fig. 1) (17). A homolog of this domain has been found on more than 20 bacterial regulatory proteins whose activities are known or thought to be modulated by phosphorylation (reviewed in references 1 and 55). The role of phosphorylation in governing the function of NtrC is believed to be in modulation of the cooperativity of NtrC dimers to form a tetrameric or oligomeric activation complex that possesses the ATPase activity necessary for driving $E\sigma^{54}$ into the open complex (42, 57).

FlbD is unusual among the transcription activators of the NtrC family, because its amino-terminal domain contains only one (D-52) of the three residues (D-12, D-54, and K-104) present in most other members of this response regulator family (Fig. 1) (53). Our results clearly indicate that, unlike NtrC, wild-type FlbD proteins activate transcriptional initiation from *flbG* (2, 4, 5), *flgF* (Fig. 2A), and *fljK* (Fig. 2B) promoters without any apparent phosphorylation. These observations suggest that unmodified FlbD contains a basal level of activity or that it uses a unique mechanism to activate the initiation of transcription from σ^{54} -dependent *fla* genes in *C. crescentus*. Other lines of evidence indicate, however, that FlbD can be phosphorylated in vivo (59) and that the high-energy-phosphate-containing molecule phosphoramidate stimulates FlbD activity in vitro (4). These results suggest a role for phosphorylation in governing FlbD function. It may be that the biologically relevant activity of FlbD requires phosphorylation or some other form of modification. Establishing a direct role for phosphorylation in the transcription regulation will rely on identification of a FlbD kinase and demonstration of its effects on FlbD activity.

Organization of cis-acting sequences. The organization of the -100 *ftr* sequence elements and the -24, and -12 promoter sequences in the *C. crescentus fla* genes is highly remi-

niscient of the structure of many globally regulated *ntr* and *nif* promoters of the enteric bacteria and *Rhizobium* spp. that promote transcription of genes involved in nitrogen assimilation. The *cis*-acting elements upstream of the *nif* and the *ntr* promoters have been shown to be functionally equivalent to enhancers and upstream activation sequences (8, 46).

We and others have previously demonstrated that FlbD, which contains a putative helix-turn-helix motif at its carboxyl terminus (Fig. 1), binds in close proximity to symmetrical guanine residues on both strands of the *ftr1*, *ftr1** (3, 32), and *ftr4* (3, 32, 58) sequences. Mutation of the *ftr1* sequence at one of these contact sites (G to T at position -113) severely inhibits transcription both in vivo (30, 31) and in vitro (3). These results, in conjunction with the results of transcription assays on templates with mutated *ftr* sequences presented here, demonstrate that the conserved guanine residues are critical for FlbD function at these promoters. Our results also suggest that pairs of *ftr* sequence elements may maximize oligomerization of the FlbD protein near the σ^{54} -dependent promoters. This conclusion is supported by the symmetry of FlbD binding to the arms of the *ftr* dyad (3), the organization of many class III gene *ftr* sequence elements in pairs (Table 1), and the observation that *ftr* mutations significantly reduce the levels of transcription from cognate promoters both in vitro (Fig. 4 and 5) and in vivo (Tables 3 and 4). Thus, FlbD may function as an oligomer. The requirement of oligomerization for transcriptional activation has been demonstrated with NtrC (42, 57) and FNR (21). It has been proposed that binding pairs of dimers facilitates the formation of a tetrameric NtrC complex at low NtrC concentrations that can effectively catalyze isomerization of the closed $E\sigma^{54}$ complex into the open complex (42, 57). Further biochemical experiments will be necessary to demonstrate that FlbD activates transcription by a similar mechanism.

In addition to the *ftr* elements studied in this report, two other sequence elements have been reported upstream from several class III promoters (reviewed in reference 6). A sequence designated RF-2 has been identified upstream of the *flgH* gene promoter (12), and a second conserved sequence element termed RF-3 has been reported upstream of the *flgI* (18) and the *flgF* (51) promoters. The RF-3 sequences have not been examined genetically, but alignment of these sequences with the *ftr* sequences in Table 1 suggests that they are in fact *ftr* elements: the RF-3 in *flgF* corresponds to *ftr5**, and the RF-3 in *flgI* corresponds to *ftr6** (Table 1).

The similarity of the RF-2 site to the consensus NifA binding site has been noted previously by Dingwall et al. (12), and these authors suggested that it behaves as a functional homolog of the NifA binding site in *flgH* regulation. The *flgH* gene has been shown previously, however, to be transcribed from both its own promoter and by read-through transcription from the *flgF* operon (11), whose promoter we have examined here. Thus, the *flgH* promoter may represent a secondary means for expression of *flgH* that is independent of FlbD control. Although our transcription studies suggest that FlbD is sufficient to modulate $E\sigma^{54}$ -dependent transcription from the class III and class IV *fla* genes, other proteins may also contribute to their control. These include 70- and 90-kDa proteins in *C. crescentus* extracts that bind to *ftr* oligonucleotides (16).

Promoter efficiency. The number of protein molecules which oligomerize to form the different flagellar substructures varies widely. If the cellular concentration of each subunit reflects its abundance in the flagellum, one might speculate that fine-tuning of transcriptional efficiency would be one way to govern the relative levels of expression. The center-to-center spacing between adjacent *ftr* sites is different in individual promoters (Table 1): (i) three turns between *ftr1* and *ftr1** (*flbG*) and *ftr6*

and *ftr6** (*flgI*), which is strikingly similar to the arrangement of adjacent high-affinity binding sites for NtrC at the *glnAp2* promoter (37, 46, 49); (ii) two and one-half turns between *ftr5* and *ftr5** (*flgF*) and *ftr7* and *ftr7** (*fljK*), which is similar to that of upstream NtrC binding sites found in the *nifLA* promoter (25, 60); and (iii) one and one-half turns between *ftr9* and *ftr9** (*flgH*) and *ftr8* and *ftr8** (*fljL*), which is similar to that of two of the NtrC binding sites upstream of the *glnH* promoter (10).

We speculate that these differences in organization of *ftr* sequence elements, as well as differences in the individual *ftr* sequences, could determine the capacity of FlbD to bind and thus provide a mechanism for controlling the efficiency at which the respective promoters are transcribed. The results shown in Fig. 3 clearly indicate that much more transcription can be generated from the *flgF* and *fljK* promoters (two and one-half turns, *ftr* separation) than from the *flbG* and *flgI* promoters (three turns, *ftr* separation) under the same conditions. Moreover, our results (Fig. 6) suggest that the transcriptional efficiency from the *flgF* and *fljK* promoters in vitro is determined by the properties of *ftr* elements and not by the σ^{54} -dependent promoter itself. We base this idea on the observation that NtrC, which is likely to be functioning via non-specific binding or from solution, can stimulate open complex formation from these two promoters with equal efficiency, whereas FlbD, which presumably acts by binding *ftr* elements, shows a greater capacity to activate *fljK* transcription than *flgF* (Fig. 6).

One interpretation of our results is that binding of FlbD to two *ftr* elements with a spacing of two and one-half turns permits activation at a lower FlbD concentration than binding to sequence elements with a spacing of three turns (47). In the case of NtrC, transcription activation is most efficient when the binding sites are three helical turns apart, presumably as a consequence of more efficient oligomerization. Therefore, the difference in optimal organization of FlbD and NtrC binding sites may reflect different interactions between the FlbD and NtrC monomers in the dimeric proteins or a difference in the way that the dimers recognize their respective binding sites. It will be important to test this idea, because one alternative possibility is that the *ftr* sequence itself is responsible for the transcriptional efficiency. In this case, the *ftr* elements of *fljK*, which contains the most efficient promoter, would have higher-affinity binding sites. We note in this context that *ftr* elements *ftr7* and *ftr7** of *fljK* most closely match the *ftr* consensus shown in Table 1.

ACKNOWLEDGMENTS

We are grateful to A. Ninfa and J. Feng for kindly supplying purified *E. coli* proteins used in the in vitro transcription assays and to G. Hecht for making the PCR products used in constructing the transcriptional templates.

This work was supported by Public Health Service grant GM22299 from the National Institutes of Health. A.K.B. was supported by Public Health Service postdoctoral fellowship GM5290-01 from the National Institutes of Health.

REFERENCES

- Albright, L. M., E. Huala, and F. M. Ausubel. 1989. Prokaryotic signal transduction mediated by sensor and regulator protein pairs. *Annu. Rev. Genet.* **23**:311–336.
- Anderson, D. K., N. Ohta, J. Wu, and A. Newton. 1995. Regulation of the *Caulobacter crescentus* *rpoN* gene and function of the purified σ^{54} in flagellar gene transcription. *Mol. Gen. Genet.* **246**:697–706.
- Benson, A. K., G. Ramakrishnan, N. Ohta, J. Feng, A. Ninfa, and A. Newton. 1994. The *Caulobacter crescentus* FlbD protein acts at *ftr* sequence elements both to activate and repress transcription of cell cycle regulated flagellar genes. *Proc. Natl. Acad. Sci. USA* **91**:4989–4993.
- Benson, A. K., and J. Wu. Unpublished results.
- Benson, A. K., J. Wu, and A. Newton. 1994. The role of FlbD in regulation of flagellar gene transcription in *Caulobacter crescentus*. *Res. Microbiol.* **12**:420–430.
- Bourret, R. B., J. F. Hess, and M. I. Simon. 1990. Conserved aspartate residues and phosphorylation in signal transduction by the chemotaxis protein CheY. *Proc. Natl. Acad. Sci. USA* **87**:41–45.
- Brun, Y. V., G. Marczynski, and L. Shapiro. 1994. The expression of asymmetry during *Caulobacter* cell differentiation. *Annu. Rev. Biochem.* **63**:419–450.
- Brun, Y. V., and L. Shapiro. 1992. A temporally controlled σ -factor is required for polar morphogenesis and normal cell division in *Caulobacter*. *Genes Dev.* **6**:2395–2408.
- Buck, M., S. Miller, M. Drummond, and R. Dison. 1986. Upstream activators are present in the promoters of nitrogen fixation genes. *Nature (London)* **320**:374–378.
- Chen, L.-S., D. Mullin, and A. Newton. 1986. Identification, nucleotide sequence, and control of developmentally regulated promoters in the hook operon region of *Caulobacter crescentus*. *Proc. Natl. Acad. Sci. USA* **83**:2860–2864.
- Claverie-Martin, F., and B. Magasanik. 1991. Role of integration host factor in the regulation of the *glnHp2* promoter of *Escherichia coli*. *Proc. Natl. Acad. Sci. USA* **88**:1631–1635.
- Dingwall, A., J. D. Garman, and L. Shapiro. 1992. Organization and ordered expression of *Caulobacter* genes encoding flagellar basal body rod and ring proteins. *J. Mol. Biol.* **228**:1147–1162.
- Dingwall, A., J. W. Gober, and L. Shapiro. 1990. Identification of a *Caulobacter* basal body structural gene and a *cis*-acting site required for activation of transcription. *J. Bacteriol.* **172**:6066–6076.
- Dingwall, A., W. Y. Zhuang, K. Quon, and L. Shapiro. 1992. Expression of an early gene in the flagellar regulatory hierarchy is sensitive to an interruption in DNA replication. *J. Bacteriol.* **174**:1760–1768.
- Elliot, T., and E. P. Geiduschek. 1984. Defining a bacteriophage T4 late promoter: absence of a “–35” region. *Cell* **36**:211–219.
- Gober, J. W., and L. Shapiro. 1992. A developmentally regulated *Caulobacter* flagellar promoter is activated by 3' enhancer and IHF binding elements. *Mol. Biol. Cell* **3**:913–926.
- Gober, J. W., H. Xu, A. K. Dingwall, and L. Shapiro. 1991. Identification of *cis* and *trans*-elements involved in the timed control of a *Caulobacter* flagellar gene. *J. Mol. Biol.* **217**:247–257.
- Keener, J., and S. Kustu. 1988. Protein kinase and phosphoprotein phosphatase activities of nitrogen regulatory proteins NTRB and NTRC of enteric bacteria: roles of the conserved amino-terminal domain of NTRC. *Proc. Natl. Acad. Sci. USA* **85**:4976–4980.
- Khambaty, F. M., and B. Ely. 1992. Molecular genetics of the *flgI* region and its role in flagellum biosynthesis in *Caulobacter crescentus*. *J. Bacteriol.* **174**:4101–4109.
- Konyecsni, W. M., and V. Deretic. 1988. Broad-host-range plasmid and M13 bacteriophage-derived vectors for promoter analysis in *Escherichia coli* and *Pseudomonas aeruginosa*. *Gene* **74**:375–386.
- Kustu, S., E. Santero, J. Keener, D. Popham, and D. Weiss. 1989. Expression of σ^{54} (*ntrA*)-dependent genes is probably united by a common mechanism. *Microbiol. Rev.* **53**:367–376.
- Lazazzera, B. A., D. M. Bates, and P. J. Kiley. 1993. The activity of the *Escherichia coli* transcription factor FNR is regulated by a change in oligomeric state. *Genes Dev.* **7**:1993–2005.
- Macnab, R. M. 1992. Genetics and biogenesis of bacterial flagella. *Annu. Rev. Genet.* **26**:131–158.
- Merrick, M. J. 1993. In a class of its own—the RNA polymerase sigma factor σ^{54} (σ^N). *Mol. Microbiol.* **10**:903–909.
- Miller, J. H. 1972. Experiments in molecular genetics. Cold Spring Harbor Laboratory, Cold Spring Harbor, N.Y.
- Minchin, S. D., S. Austin, and R. A. Dison. 1988. The role of activator binding sites in transcriptional control of the divergently transcribed *nifF* and *nifLA* promoters from *Klebsiella pneumoniae*. *Mol. Microbiol.* **2**:433–442.
- Minnich, S. A., and A. Newton. 1987. Promoter mapping and cell cycle regulation of flagellin gene transcription in *Caulobacter crescentus*. *Proc. Natl. Acad. Sci. USA* **84**:1142–1146.
- Minnich, S. A., N. Ohta, N. Taylor, and A. Newton. 1988. Role of the 25-, 27-, and 29-kilodalton flagellins in *Caulobacter crescentus* cell motility: method for construction of deletion and Tn5 insertion mutants by gene replacement. *J. Bacteriol.* **170**:3953–3960.
- Mullin, D., S. Minnich, L. S. Chen, and A. Newton. 1987. A set of positively regulated flagellar gene promoters in *Caulobacter crescentus* with sequence homology to the *nif* gene promoters of *Klebsiella pneumoniae*. *J. Mol. Biol.* **195**:939–943.
- Mullin, D., and A. Newton. 1994. Unpublished results.
- Mullin, D. A., and A. Newton. 1989. Ntr-like promoters and upstream regulatory sequence *ftr* are required for transcription of a developmentally regulated *Caulobacter crescentus* flagellar gene. *J. Bacteriol.* **171**:3218–3227.
- Mullin, D. A., and A. Newton. 1993. A σ^{54} promoter and downstream sequence elements *ftr2* and *ftr3* are required for regulated expression of divergent transcription units *flaN* and *flbG* in *Caulobacter crescentus*. *J. Bacteriol.* **175**:2067–2076.

32. **Mullin, D. A., S. M. Van Way, C. A. Blankenship, and A. H. Mullin.** 1994. FliB has a DNA-binding activity near its carboxy terminus that recognizes *flr* sequences involved in positive and negative regulation of flagellar gene transcription in *Caulobacter crescentus*. *J. Bacteriol.* **176**:5971–5981.
33. **Newton, A., and N. Ohta.** 1990. Regulation of the cell division cycle and differentiation in bacteria. *Annu. Rev. Microbiol.* **44**:689–719.
34. **Newton, A., N. Ohta, G. Ramakrishnan, D. Mullin, and G. Raymond.** 1989. Genetic switching in the flagellar gene hierarchy of *Caulobacter* requires negative as well as positive regulation of transcription. *Proc. Natl. Acad. Sci. USA* **86**:6651–6655.
35. **Ninfa, A., and B. Magasanik.** 1986. Covalent modification of the *glnG* product, NRI, by the *glnL* product, NRII, regulates the transcription of the *glnALG* operon in *Escherichia coli*. *Proc. Natl. Acad. Sci. USA* **83**:5905–5913.
36. **Ninfa, A. J., D. A. Mullin, G. Ramakrishnan, and A. Newton.** 1989. *Escherichia coli* σ^{54} RNA polymerase recognizes *Caulobacter crescentus* *flaG* and *flaN* flagellar gene promoters in vitro. *J. Bacteriol.* **171**:383–391.
37. **Ninfa, A. J., L. J. Reitzer, and B. Magasanik.** 1987. Initiation of transcription at the bacterial *glnAp2* promoter by purified *E. coli* components is facilitated by enhancers. *Cell* **50**:1039–1046.
38. **Ohta, N., L.-S. Chen, D. Mullin, and A. Newton.** 1991. Timing of flagellar gene expression in the *Caulobacter* cell cycle is determined by a transcriptional cascade of positive regulatory genes. *J. Bacteriol.* **173**:1514–1522.
39. **Ohta, N., L. S. Chen, E. Swanson, and A. Newton.** 1985. Transcriptional regulation of a periodically controlled flagellar gene operon in *Caulobacter crescentus*. *J. Mol. Biol.* **186**:107–115.
40. **Ohta, N., E. Swanson, B. Ely, and A. Newton.** 1984. Physical mapping and complementation analysis of transposon Tn5 mutations in *Caulobacter crescentus*: organization of transcriptional units in the hook gene cluster. *J. Bacteriol.* **158**:897–904.
41. **Osley, M. A., M. Sheffery, and A. Newton.** 1977. Regulation of flagellin synthesis in the cell cycle of *Caulobacter*: dependence on DNA replication. *Cell* **12**:393–400.
42. **Porter, S. C., A. K. North, A. B. Wedel, and S. Kustu.** 1993. Oligomerization of NTRC at the *glnA* enhancer is required for transcriptional activation. *Genes Dev.* **7**:2258–2273.
43. **Ramakrishnan, G., and A. Newton.** 1990. FliB of *Caulobacter crescentus* is a homologue of NtrC (NR_I) and activates sigma-54 dependent flagellar gene promoters. *Proc. Natl. Acad. Sci. USA* **87**:2369–2373.
44. **Ramakrishnan, G., J.-L. Zhao, and A. Newton.** 1991. The cell-cycle regulated flagellar gene *flbF* of *Caulobacter crescentus* is homologous to the virulence locus (*lcrD*) of *Yersinia pestis*. *J. Bacteriol.* **173**:7283–7292.
45. **Ramakrishnan, G., J.-L. Zhao, and A. Newton.** 1994. Multiple structural proteins are required for both transcriptional activation and negative auto-regulation of *Caulobacter* flagellar genes. *J. Bacteriol.* **176**:7587–7600.
46. **Reitzer, L. J., and B. Magasanik.** 1986. Transcription of *glnA* in *E. coli* is stimulated by activator bound to sites far from the promoter. *Cell* **45**:785–792.
47. **Reitzer, L. J., B. Movsas, and B. Magasanik.** 1994. Activation of *glnA* transcription by nitrogen regulator I (NR_I)-phosphate in *Escherichia coli*: evidence for a long-range physical interaction between NR_I-phosphate and RNA polymerase. *J. Bacteriol.* **171**:5512–5522. (Abstract.)
48. **Sanders, L. A., S. Van Way, and D. A. Mullin.** 1992. Characterization of the *Caulobacter crescentus* *flbF* promoter and identification of the inferred FliB product as a homolog of the LcrD protein from a *Yersinia enterocolitica* virulence plasmid. *J. Bacteriol.* **174**:857–866.
49. **Sasse-Dwight, S., and J. D. Gralla.** 1990. Role of eukaryotic-type functional domains found in the prokaryotic enhancer receptor factor σ -54. *Cell* **62**:945–954.
50. **Sheffery, M., and A. Newton.** 1981. Regulation of periodic protein synthesis in the cell cycle: control of initiation and termination of flagellar gene expression. *Cell* **24**:49–57.
51. **Sommer, J. M.** 1988. Cell division and differentiation. Ph.D. dissertation. Princeton University, Princeton, N.J.
52. **Stephens, C. M., and L. Shapiro.** 1993. An unusual promoter controls cell-cycle regulation and dependence on DNA replication of the *Caulobacter* *fliLM* early flagellar operon. *Mol. Microbiol.* **9**:1169–1179.
53. **Stock, J. B., A. J. Ninfa, and A. M. Stock.** 1989. Protein phosphorylation and regulation of adaptive responses in bacteria. *Microbiol. Rev.* **53**:450–490.
54. **Van Way, S. M., A. Newton, A. H. Mullin, and D. A. Mullin.** 1993. Identification of the promoter and a negative regulatory element, *ftr4*, that is needed for cell cycle timing of *fliF* operon expression in *Caulobacter crescentus*. *J. Bacteriol.* **175**:367–376.
55. **Weiss, D. S., J. Batut, K. E. Klose, J. Keener, and S. Kustu.** 1991. The phosphorylated form of the enhancer-binding protein NTRC has an ATPase activity that is essential for activation of transcription. *Cell* **67**:155–167.
56. **Weiss, D. S., K. E. Klose, T. R. Hoover, and A. K. North.** 1995. Prokaryotic transcriptional enhancers, p. 667–694. In S. L. McKnight and K. R. Yamamoto (ed.), *Transcriptional regulation*. Cold Spring Harbor Laboratory Press, Cold Spring Harbor, N.Y.
57. **Weiss, D. S., and B. Magasanik.** 1988. Phosphorylation of nitrogen regulator I (NRI) of *Escherichia coli*. *Proc. Natl. Acad. Sci. USA* **85**:8919–8923.
58. **Wingrove, J. A., and J. W. Gober.** 1994. A σ^{54} transcriptional activator also functions as a pole-specific repressor in *Caulobacter*. *Genes Dev.* **8**:1839–1852.
59. **Wingrove, J. A., E. K. Mangan, and J. W. Gober.** 1993. Spatial and temporal phosphorylation of a transcriptional activator regulates pole-specific gene expression in *Caulobacter*. *Genes Dev.* **7**:1979–1992.
60. **Wong, P.-K., D. Popham, J. Keener, and S. Kustu.** 1987. In vitro transcription of the nitrogen fixation regulatory operon *nifLA* of *Klebsiella pneumoniae*. *J. Bacteriol.* **169**:2876–2880.
61. **Xu, H., A. Dingwall, and L. Shapiro.** 1989. Negative transcriptional regulation in the *Caulobacter* flagellar hierarchy. *Proc. Natl. Acad. Sci. USA* **86**:6656–6660.
62. **Yu, J., and L. Shapiro.** 1992. Early *Caulobacter crescentus* genes *fliL* and *fliM* are required for flagellar gene expression and normal cell division. *J. Bacteriol.* **174**:3327–3338.