

University of Nebraska - Lincoln

DigitalCommons@University of Nebraska - Lincoln

Faculty Publications from the Department of
Electrical and Computer Engineering

Electrical & Computer Engineering, Department of

2012

Real-time Optimal Participation of Wind Power in an Electricity Market

Ting Dai

University of Nebraska-Lincoln, ting.dai@huskers.unl.edu

Wei Qiao

University of Nebraska-Lincoln, wqiao@engr.unl.edu

Liyan Qu

Member, IEEE, liyanqu@ieee.org

Follow this and additional works at: <http://digitalcommons.unl.edu/electricalengineeringfacpub>



Part of the [Electrical and Computer Engineering Commons](#)

Dai, Ting; Qiao, Wei; and Qu, Liyan, "Real-time Optimal Participation of Wind Power in an Electricity Market" (2012). *Faculty Publications from the Department of Electrical and Computer Engineering*. 164.

<http://digitalcommons.unl.edu/electricalengineeringfacpub/164>

This Article is brought to you for free and open access by the Electrical & Computer Engineering, Department of at DigitalCommons@University of Nebraska - Lincoln. It has been accepted for inclusion in Faculty Publications from the Department of Electrical and Computer Engineering by an authorized administrator of DigitalCommons@University of Nebraska - Lincoln.

Real-time Optimal Participation of Wind Power in an Electricity Market

Ting Dai, *Student Member, IEEE*, Wei Qiao, *Member, IEEE*, and Liyan Qu, *Member, IEEE*

Abstract—While integrating wind power into the electricity market can reduce the operational and fuel costs of the power system, it also increases the imbalance cost and the need for reserve. Due to this contradictory, there is a need for planning the amount of wind power in the power system. This paper proposes a model to determine the real-time optimal participation of wind power in an electricity market. This model assumes that the system operator will regulate the participation level of the wind power due to the increasing cost of reserve. Case studies are presented to demonstrate the use of the proposed model to determine the real-time optimal participation of wind power in a practical power system for various scenarios.

Index Terms—Electricity market, optimal participation, reserve, wind power

I. NOMENCLATURE

Indices:

- g Index of conventional generators, running from 1 to N_G .
 b Index of offering curve block number of conventional generators, running from 1 to B .

Variables:

- P_{gt}^D Accepted day-ahead market power of generating unit g at time t .
 P_{gt}^R Accepted reserve market power of generating unit g at time t .
 W_t Forecasted wind power production at time t .
 Δp_{gb}^D The increased bid energy in block b of the offering curve of generator g at time t .
 λ_{gb}^D Bid price for block b of the offering curve of generator g at time t .
 w_t Optimal wind power production accepted at time t .
 P_{wt}^R Required reserve in the system when the accepted wind penetration is w at time t .
 u_{gt} State of a conventional unit g at time t , where $u = 1$ means ON and $u = 0$ means OFF.

Constants and Parameters:

- P_g^{\min} Minimum power output of a generator g .
 P_g^{\max} Maximum power output of a generator g .
 a_g, b_g Thermal heat rate curve parameters.
 $StUP_g$ Start-up cost for a generator g .

II. INTRODUCTION

WIND power is a clean, renewable but intermittent energy source. Due to the increasing concerns over environmental problems and climbing prices of natural gas and oil, in recent year, there has been a dramatic increase in the amount of wind power installed around the world. Many countries, e.g., Denmark, Germany, Spain, Ireland, Great British, China, India, and the United States, have plans to further increase the installed wind capacity [1]. Currently, most of the wind power in the United States is being sold on long-term power purchasing agreements (PPAs). However, there is an interest in merchant wind generation, and some of the wind generation in the United States is already being sold directly into the day-ahead and real-time electricity markets [2].

However, high-level participation of wind power in the power market is a challenge to system stability and security due to the fluctuation and partial unpredictability in the wind power production. Technically this means that a higher penetration level of wind power will require a higher capacity of spinning and nonspinning reserves and an increasing use of these reserves. The ability of a power system to absorb wind power depends largely on its existing reserve capacity. Moreover, the prices in ancillary service markets are expected to increase as well. On the other hand, fuel and operation costs of the whole system are expected to decrease with the increase of wind penetration. Such a contradiction indicates that there exists an optimal level of wind penetration into a system in terms of the total profit of the system. For an Independent System Operator (ISO), this total profit translates to the social welfare that is realized through the market optimization.

This paper investigates the issue of real-time optimal participation of wind power in an electricity market to maximize the total profit of the whole market during each one-hour operation period. Since the day-ahead price, reserve requirement, and wind power production fluctuate over time, the optimal participation level of wind power through a whole year will be studied to investigate the influence of day-ahead and reserve prices as well as energy storage on wind power penetration.

This paper is organized as follows. The method of determining required reserve for different levels of wind power penetration is presented in Section III. Section IV describes the proposed model of determining the real-time optimal wind power penetration level in an electricity market. Case studies are provided in Section V to demonstrate the use of the proposed model to determine the real-time optimal participation of wind power in the New England 39-bus power system. The main findings of the

This work was supported in part by the U.S. National Science Foundation under CAREER Award ECCS-0954938.

The authors are with the Department of Electrical Engineering, University of Nebraska–Lincoln, Lincoln, NE 68588-0511 USA (e-mail: ting.dai@huskers.unl.edu; wqiao@engr.unl.edu; liyanqu@iieee.org).

paper are summarized in the last section.

III. RESERVE DETERMINATION

The large-scale integration of wind generation into a power system presents a significant challenge to system operators due to the unpredictable and intermittent characteristics of wind power generation outputs. If wind power producers actively participate in the power market, the uncertainty in wind generation will increase the uncertainty on the supply side. This increased uncertainty must be taken into account when determining the requirement for reserve to ensure safe operation of the system during unforeseen events.

Traditionally, reserve requirement has been determined based on a criterion of ensuring safe operation of the power system during the loss of the largest online infeed [3]. Such a deterministic criterion takes into account neither the accuracy of the demand or wind power forecast, nor the probability of the largest generator or interconnection outage or the consequences of such a contingency. New methods have been developed recently to deal with reserve requirement in the system with significant wind power penetration; and conclusions have been drawn on this problem. One of the rules of determining reserves is inspired by a recent report published by the National Renewable Energy Laboratory [4], which proposed a heuristic approach called the 3+5 rule for committing spinning reserve. The 3+5 rule requires a power system to carry hourly spinning reserve no less than 3% of hourly forecasted load plus 5% of hourly forecasted wind power. Dany [5] investigated and quantified the impact of the wind penetration level on the primary, secondary, and tertiary reserves as they were applied to the interconnected German power system. He concluded that reserve requirements increase proportionally to the installed wind power capacity. However, the uncertainty of large-scale integration of wind power necessitates more sophisticated methods for determine operating reserves. Recently, stochastic programming has been increasingly used in wind integration study [6]-[9]. In addition to co-optimizing generation schedules and reserve requirements, stochastic programming can also be used to analyze economic impacts of wind penetration in a power system. It has become a popular tool for analyzing large-scale wind power penetration problems.

In this paper, the method provided in [10] is used to determine the relationship between reserve requirement and wind penetration. Generator outage rates as well as wind and load forecast errors are taken into consideration when quantifying the amount of reserve needed. The reliability of the system is used as an objective measure to investigate the effect of increasing wind power penetration.

A. Wind Power and Load Forecast Error

Some reports show that wind prediction errors at a single site follow β -distributions instead of Gaussian distributions [11], [12]. However, the large number and geographical distribution of wind turbines allows the application of the central limit theorem to justify the assumption of normally distributed wind power prediction errors, which is a common practice in the literature [10], [13]-[15]. In this paper, it is assumed that a large number of wind power

generating units with a rich geographical diversity have been installed in the power system. Therefore, the forecast error of wind power production in a certain hour can be modeled as a Gaussian stochastic variable with a mean of zero and a standard deviation of $\sigma_{w,t}$.

Due to the highly repetitive nature of the daily load profile, load forecast errors are not especially sensitive to the forecast horizon and are usually proportional to the load level at a given hour. The load forecast error in a certain hour then can be modeled as a Gaussian stochastic variable with a mean of zero and a standard deviation of $\sigma_{l,t}$ as well.

It is assumed that both the load and wind power forecast errors are uncorrelated Gaussian stochastic variables, then the standard deviation of the total system forecast error $\sigma_{total,t}$ can be calculated by

$$\sigma_{total,t} = \sqrt{\sigma_{w,t}^2 + \sigma_{l,t}^2} \quad (1)$$

B. Reserve Calculation

There are many different reliability criteria used in power system analysis. In this paper, the reliability criterion is defined as the number of Load Shedding Incident (LSI) being tolerated per year, where a LSI is an incident when there is no enough reserve to meet a generation shortfall. The LSI is equal to the loss of load expectation (LOLE) reliability criterion used in many electricity systems by multiplying the average time for which the load is shed.

The methodology in [10] relates the reserve level of the system in each hour to the reliability of the system over the year. At a certain hour h , the probability of load shedding, PLS_h , which depends on the level of reserve, should meet the following reliability criterion.

$$0 \leq PLS_h \leq \frac{LSI}{8760} \quad (2)$$

Load shedding may happen in three different scenarios: 1) having an unforecasted wind and load variation greater than the system reserve level; 2) having a generation trip (full or partial) and an unforecasted wind and load variation greater than the system reserve level; and 3) having a generation trip and an unforecasted wind and load variation after a previous generation trip before any load shedding action is taken.

At a certain reserve level, the probabilities of the three load shedding scenarios can be calculated and added together to get the probability of load shedding PLS_h . Therefore, the reserve requirement, i.e., the minimum level of reserve ensuring that PLS_h the reliability criterion (2) is met, can be determined.

The New England 39-bus system is used as example to show the method used for reserve calculation. Fig. 1 shows the single-line diagram of the system, which comprises 10 generators, 39 buses, and 46 lines. The system has ten conventional generators with a total installed generating capacity of 7,500 MW. The data of the ten generators are listed in Table 1. Suppose that additional 7,500 MW wind power is installed in the system, which consists 50% of the total capacity of the system. The probability of generation outages ranges from 0.003 for the least reliable units to 0.0006 for the most reliable units. The reserve requirement is solved by using MATLAB optimization toolbox. Fig. 2 shows the required reserve level against the level of wind

power penetration for different values of LSI in a certain year. As the wind power penetration increases, the system reserve level must also increase or the whole system will suffer a decrease in reliability. It can be seen that 50% penetration of wind capacity results in roughly 100% increase in the need for reserve capacity. This consequently will result in the increase of the cost of reserve.

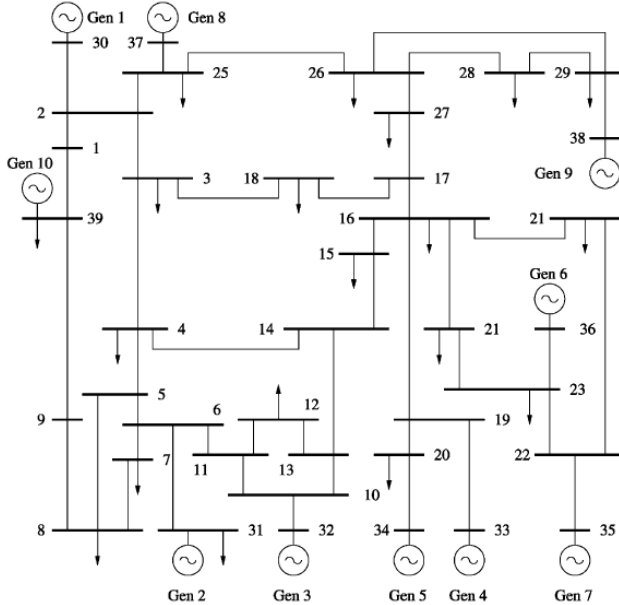

Fig. 1. One-line diagram of the New England 10-machine, 39-bus system.

TABLE I
GENERATION DATA

Generator Number	Bus Number	a_g	b_g	P_g^{\max}	P_g^{\min}	$StUP_g$
1	30	0.834	2.50	350	0	800
2	31	0.650	0	650	0	900
3	32	0.834	0	800	0	850
4	33	0.824	0	750	0	850
5	34	0.814	0	650	0	850
6	35	0.804	0	750	0	850
7	36	0.830	0	750	0	850
8	37	0.800	0	700	0	850
9	38	0.650	0	900	0	870
10	39	0.600	0	1,200	0	920

IV. MODEL DESCRIPTION

The proposed model to solve the real-time optimal wind power penetration problem is defined as a single region model, where trading power with other markets is not considered. Additionally, it is assumed that the transmission capacity is sufficient in the system and transmission congestions will not happen. The conventional power producers are required to submit an offering curve for each hour of the trading day considered. These curves are submitted by the producers to the day-ahead market that is cleared the day before the actual power delivery takes place. The energy which is offered at a price equal to or lower than the market clearing price will be accepted by the market operator. The security of the system is maintained through purchasing some level of reserve according to the level of predicted wind penetration, as described in the previous section. These reserves can be provided by generators whose productions have not been fully accepted by the market operator in the day-ahead market. The system

operator will choose from the least cost to the most expensive reserve until the required reserve amount is met. The mathematical formulation to solve for the real-time optimal penetration of wind power is given as follows.

$$\begin{aligned} \text{Max } V_{obj} = & \lambda_t^D \left(\sum_{g=1}^{N_G} P_{gt}^D + w_t \right) + \lambda_t^R \sum_{g=1}^{N_G} P_{gt}^R \\ & - \sum_{g=1}^{N_G} \{ C_g (P_{gt}^D + P_{gt}^R) - \max[0, StUP_{gt} (u_{gt} - u_{g(t-1)})] \} \end{aligned} \quad (3)$$

Subject to:

$$P_g^{\min} \leq P_{gt}^D + P_{gt}^R \leq P_g^{\max}, \quad g = 1, \dots, N_g \quad (4)$$

$$P_{gt}^D = \sum_{b=1}^{B(\lambda_{gt}^D)} \Delta p_{gtb}^D, B(\lambda_{gt}^D) = \max(b) \text{ such that } \lambda_{gtb}^D \leq \lambda_t^D, \quad (5)$$

$$g = 1, \dots, N_g$$

$$\sum_{g=1}^{N_G} P_{gt}^R = P_{wt}^R, \quad g = 1, \dots, N_g \quad (6)$$

$$C_g(P) = a_g P^2 + b_g P, \quad g = 1, \dots, N_g \quad (7)$$

$$0 \leq w_t \leq W_t \quad (8)$$

where the objective function (3) is to maximize the total profit of the system, which is the revenue minus fuel costs and start-up costs of the generators.

Constraint (4) bounds the maximum and minimum production of the generators. The accepted energy selling into day-ahead and reserve market are calculated in constraints (5) and (6), respectively. The cost function of each generator is expressed in (7). Constraint (8) states that the wind production accepted by the system operator should not exceed the forecasted wind power production.

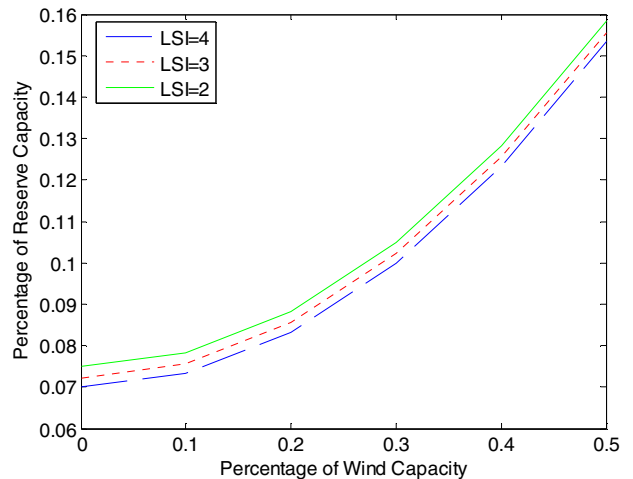

Fig. 2. The required system reserve level against the level of wind power penetration for three different values of LSI.

V. CASE STUDY

The proposed model is examined with the IEEE New England 39-bus system shown in Fig. 1. In this paper, a five-block offer strategy is used for each generator in the energy market, as shows in Fig. 3. The offer curve is generated by dividing the interval of the maximum and minimum capacities of the generator into five blocks of equal length and then offering the power capacities at the price equal to the incremental cost (i.e., $\lambda_1 \sim \lambda_5$) for each of the five blocks. The incremental cost is the derivative of the quadratic cost functions of the generator defined in (6).

The data of day-ahead price and reserve price can be obtained from the New England Power Market website [16]. The data for 2010 are chosen for all case studies. All cases are simulated in MATLAB.

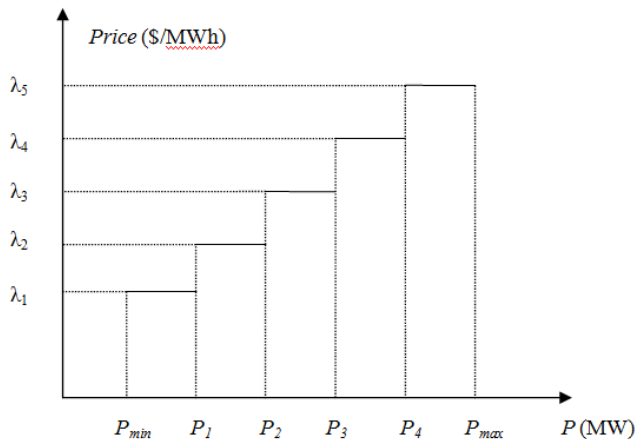

Fig. 3. A 5-block offer curve for a generator in the energy market.

A. Case 1: Impact of Seasonal Day-Ahead Market Clearing Price

The day-ahead price fluctuates during the whole year. In winter (December, January, and February) and summer (June, July, and August), the day-ahead price is usually high due to the high demand; while the day-ahead price is relatively low in spring (March, April, and May) and fall (September, October, and November) because the demand declines. The mean values of the day-ahead price of the New England power market during spring, summer, fall, and winter of 2010 are \$42.25, \$57.18, \$43.20, and \$61.78 per MWh, respectively. The standard deviations of the New England power market of spring, summer, fall, winter are \$10.59, \$25.29, \$13.9252, and \$20.5653, respectively. In this case, the impact of seasonal day-ahead price on the real-time optimal penetration of wind power is analyzed by fixing the wind power production to be 7,500 MW and reserve price to be \$60/MWh during each hour. The system reliability criteria LSI is chosen to be 2. The results of the optimal wind power penetration level in each hour in different seasons of 2010 are shown in Fig. 4. The statistical results of the optimal wind power penetration level in each hour in different seasons are summarized in Table 2.

From Fig. 4 and Table 2, it can conclude that the day-ahead market clearing price has great impact on the optimal penetration level of wind power production. A higher day-ahead price will result in a higher penetration level of wind power, such as in winter and summer; while a lower day-ahead price will result in a lower penetration level of wind power, such as in spring and fall. These results are expected as wind power can bring more revenue under a higher day-ahead price, which can cover the cost of buying more reserve power.

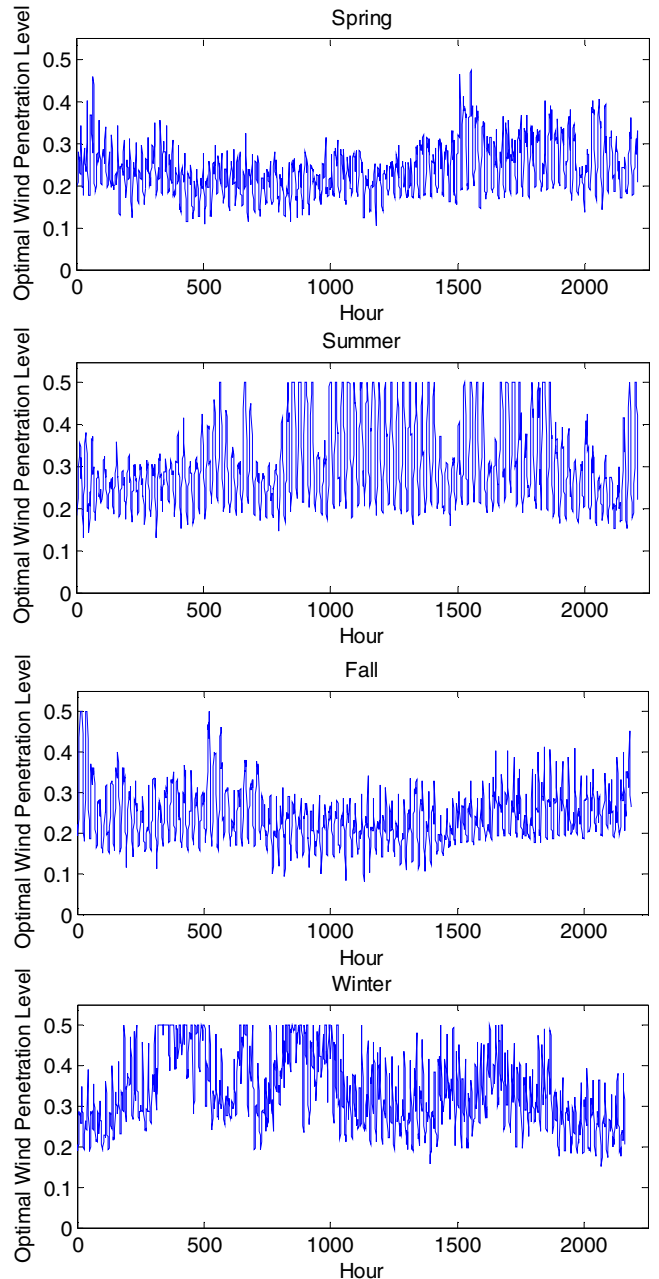

Fig. 4. Optimal wind power penetration level during each hour in different seasons of 2010.

TABLE II
STATISTICAL SUMMARY OF OPTIMAL WIND PENETRATION LEVEL IN DIFFERENT SEASONS

Season	Optimal penetration of wind			
	Mean value (%)	Maximum value (%)	Minimum value (%)	Standard deviation
Spring	18.11	50	8.06	0.0454
Summer	24.05	50	10.07	0.0924
Fall	18.43	50	6.18	0.0535
Winter	26.33	50	11.66	0.0829

B. Case 2: Impact of Reserve Price

In this case, the day-ahead price and reserve price data from the New England power market in 2010 is used. The real wind power data from the site 5659 on the National Renewable Energy Laboratory (NREL) website [17] is selected for the case study. The system reliability criterion LSI is chosen to be 2. The average reserve price of the New England power market is \$69.71 in 2010. The cost for all

the reserve has increased by 266% from 2009 due to the extended, unexpected outage of a large resource and higher load levels during summer. With a higher level of wind power penetration in the system, the reserve price will increase due to a higher demand. In this case, the reserve price is increased by 20% and the impact of the reserve price on the optimal penetration of wind power is analyzed. The optimal wind penetration levels of the New England 39-bus power system in 2010 using the original and 20% increased reserve price data are shown in Fig. 5. The difference between the two cases is shown in Fig. 6.

From Figs. 5 and 6, the increased reserve price results in the decrease of the optimal wind power penetration level. The mean value of the optimal wind power penetration level has decreased from 11.24% to 9.59%. The high reserve price is an obstacle to wind power participating in the system.

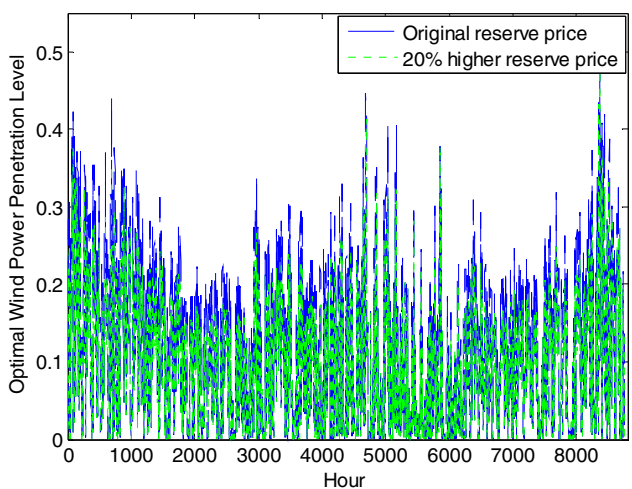

Fig. 5. Optimal wind power penetration levels in 2010 using original reserve price and 20% increased reserve price.

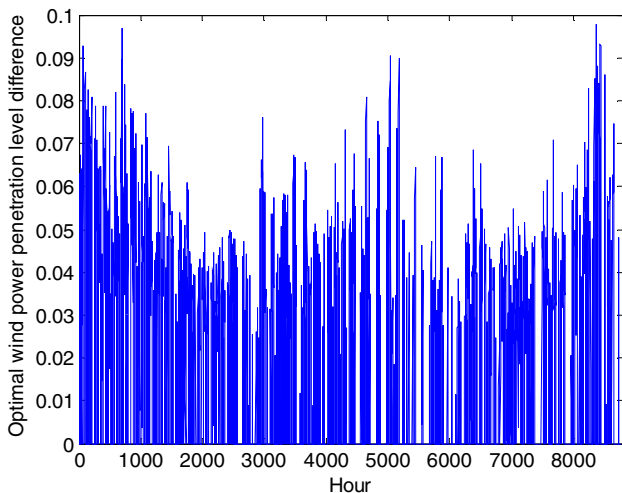

Fig. 6. Difference between the optimal wind power penetration price levels using original reserve price and 20% increased reserve price.

C. Case 3: Impact of Installing Energy Storage

The use of energy storage integrated with wind power is commonly considered as a means to increase the flexibility of a power system. If wind plants can operate along with energy storage, the total amount of reserve can decrease. Table 3 shows the costs for two commonly used energy storage technologies: pumped hydro and compressed air energy storage (CAES). The costs of these two energy

storage systems are much lower than that of reserve in the system. If 20% of the required reserve capacity is replaced by the CAES, the cost of reserve will decrease and more wind power will be accepted by the system operator. The optimal wind penetration levels of the New England 39-bus power system in 2010 using and without using CAES are shown in Fig. 7. The difference between the two cases is shown in Fig. 8.

From Figs. 7 and 8, when CAES is used in the system, the optimal wind penetration level is clearly higher than that without using CAES. The use of CAES will lower the operation cost of the system and thus increase the mean value of the optimal wind penetration level from 11.44% to 16.14%. The use of low-cost energy storage provides an economic way for accommodating more wind penetration in the system.

TABLE III
COSTS OF TWO DIFFERENT TYPES OF ENERGY STORAGE

Type	Pumped hydro	CAES
Start-up cost (\$/MW)	10.1	5.5
Other variable cost (\$/MWh)	3.4	1.6
Fixed operation cost (\$/MW)	34.7	30.6

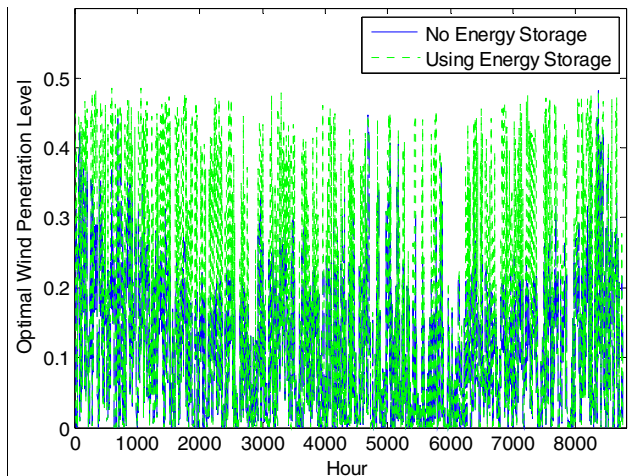

Fig. 7. Optimal wind power penetration levels in 2010 using and without using CAES.

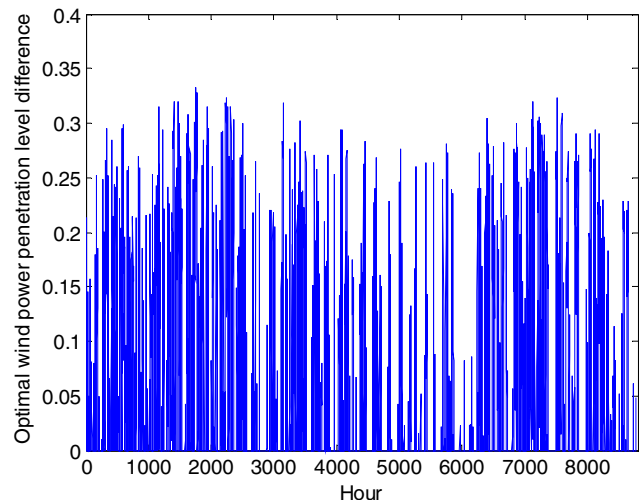

Fig. 8. Difference between the optimal wind power penetration levels using and without using CAES.

VI. CONCLUSION

Wind Power has a great potential to participate in the current power market to reduce the operational and fuel costs of the system. However, due to the inherent uncertainties in wind power forecasts, the increase of wind penetration will lead to the increase in reserve cost. In this paper, a model has been presented to solve such contradictory. The reserve required to meet the system reliability at different levels of wind power penetration has been determined based on probability of generator outage and wind and load forecast errors. The model optimizes the real-time wind power penetration level by maximizing the total profit of the system.

The New England 39-bus system has been used to test the proposed model by using the data obtained from the New England power market. According to the case studies, the day-ahead market clearing price has a great impact on the real-time optimal wind penetration level. A higher day-ahead clearing price will result in the increase of the acceptable wind power penetration level. The increase of the reserve price, on the other hand, has been proven to be an obstacle to increasing wind power penetration level. The use of low-cost energy storage provides a good way for accommodating more wind penetration in the system. This paper has provided an effective method to assess the real-time optimal wind power penetration level in the market.

In future work, stochastic programming will be used to determine more accurate real-time reserve for different penetration levels of wind power. Additionally, considering wind power producers as participants in the market who submit offer curves as other conventional producers as well as transmission capacity constraints is a more practical way to investigate this problem.

VII. REFERENCES

- [1] Bolinger, M. & Wiser, R. "2008 Wind technologies market report," Lawrence Berkeley National Laboratory, 2009.
- [2] A. Bottetud, J. Wang, R. J. Bessam, and V. Miranda, "Risk management and optimal bidding for a wind power producer," *In Proc. IEEE PES General Meeting 2010*, Minneapolis, Minnesota, USA, 2010.
- [3] Christoph, W., Peter, M., Rudiger, B. A. J. Wood and B. F. Wollenberg, *Power Generation, Operation and Control*, 2nd ed. New York: Wiley, 1996.
- [4] WesternWind and Solar Integration Study, National Renewable Energy Lab., May 2010, Tech. Rep.
- [5] G. Dany, "Power reserve in interconnected systems with high wind power production," in *Proc. IEEE Porto Power Tech*, Porto, Portugal, 2001.
- [6] P. A. Ruiz, C. R. Philbrick, and P. W. Sauer, "Wind power day-ahead uncertainty management through stochastic UC policies," in *Proc. Power Systems Conf. Expo.*, Mar. 2009, pp. 1–9.
- [7] T. Mount, L. Anderson, J. Cardell, A. Lamadrid, S. Manevitjit, B. Thomas, and R. Zimmerman, *The Economic Implications of Adding Wind Capacity to a Bulk Power Transmission Network Applied Economics and Management*, Ithaca, NY, Cornell Univ., 2008, Tech. Rep.
- [8] F. Bouffard and F. D. Galiana, "Stochastic security for operations planning with significant wind power generation," *IEEE Trans. Power Syst.*, vol. 23, no. 2, pp. 306–316, May 2008.
- [9] J. M. Morales, A. J. Conejo, and J. Perez-Ruiz, "Economic valuation of reserves in power systems with high penetration of wind power," *IEEE Trans. Power Syst.*, vol. 24, no. 2, pp. 900–910, May 2009.
- [10] R. Doherty and M. O'Malley, "A new approach to quantify reserve demand in systems with significant installed wind capacity," *IEEE Trans. Power Syst.*, vol. 20, no. 2, pp. 587–595, May 2005.
- [11] S. Bofinger, A. Luig, and H. G. Beyer, "Qualification of wind power forecasts," in *Proc. Global Wind Power Conf.*, Paris, France, 2002.

- [12] A. Fabbri, T. Gomez, S. Roman, J. R. Abbad, and V. H. M. Quezada, "Assessment of the cost associated with wind generation prediction errors in a liberalized electricity market," *IEEE Trans. Power Syst.*, vol. 20, no. 3, pp. 1440–1446, Aug. 2005.
- [13] L. Söder, "Reserve margin planning in a wind-hydro-thermal power system," *IEEE Trans. Power Syst.*, vol. 8, no. 2, pp. 564–571, May 1993.
- [14] F. Bouffard and F. D. Galiana, "Stochastic security for operations planning with significant wind power generation," *IEEE Trans. Power Syst.*, vol. 23, no. 2, pp. 306–316, May 2008.
- [15] E. D. Castronuovo and J. A. P. Lopes, "On the optimization of the daily operation of a wind-hydro power plant," *IEEE Trans. Power Syst.*, vol. 19, no. 3, pp. 1599–1606, Aug. 2004.
- [16] New England Power Market [Online]: Available: <http://www.isone.com/markets/index.html>
- [17] National Renewable Energy Laboratory (NREL) [Online]: Available: <http://www.nrel.gov/wind/integrationdatasets/eastern/methodology.html>
- [18] New England 2010 Annual Markets Report [Online]: Available: http://www.isone.com/markets/mkt_anlys_rpts/annl_mkt_rpts/2010/mr10_final_060311.pdf

Ting Dai (S'10) received a B.Eng. degree in electrical engineering from Xi'an Jiaotong University, Xi'an, China in 2009. Currently, she is working towards the Ph.D. degree in the Department of Electrical Engineering at the University of Nebraska-Lincoln (UNL). Her research interests include power system control and operation and electricity market.

Wei Qiao (S'05–M'08) received a B.Eng. and M.Eng. degrees in electrical engineering from Zhejiang University, Hangzhou, China, in 1997 and 2002, respectively, an M.S. degree in high performance computation for engineered systems from Singapore-MIT Alliance (SMA), Singapore in 2003, and a Ph.D. degree in electrical engineering from Georgia Institute of Technology, Atlanta in 2008.

From 1997 to 1999, he was an Electrical Engineer with China Petroleum & Chemical Corporation (Sinopec). He is currently the Harold and Esther Assistant Professor with the Department of Electrical Engineering at UNL. His research interests include renewable energy systems, smart grids, microgrids, power system control and optimization, condition monitoring and fault diagnosis, energy storage systems, power electronics, electric machines and drives, and computational intelligence for electric power and energy systems. He is the author or coauthor of 3 book chapters and more than 90 papers in refereed journals and international conference proceedings.

Dr. Qiao is an Associated Editor of the IEEE Transactions on Industry Applications, the Chair of the Technical Thrust of Sustainable Energy Sources of the IEEE Power Electronics Society, and the Chair of the Task Force on Intelligent Control for Wind Plants of the IEEE Power & Energy Society. He is the Publications Chair of the 2013 IEEE Energy Conversion Congress and Exposition (ECCE 2013) and the Technical Program Co-Chair and Publications Chair of the 2012 IEEE Symposium on Power Electronics and Machines in Wind Applications (PEMWA 2012). He was the Technical Program Co-Chair and Finance Co-Chair of PEMWA 2009. Dr. Qiao was the recipient of a 2010 National Science Foundation CAREER Award, the 2010 IEEE Industry Applications Society Andrew W. Smith Outstanding Young Member Award, the 2011 UNL Harold and Esther Edgerton Junior Faculty Award, the 2011 UNL College of Engineering Edgerton Innovation Award, and the 2012 UNL College of Engineering Faculty Research & Creative Activity Award.

Liyan Qu (S'05–M'08) received the B.Eng. (with the highest distinction) and M.Eng. degrees in electrical engineering from Zhejiang University, Hangzhou, China, in 1999 and 2002, respectively, and the Ph.D. degree in electrical engineering from the University of Illinois at Urbana-Champaign in 2007.

From 2007 to 2009, she was an Application Engineer with Ansoft Corporation. Currently, she is a Senior Lecturer with the Department of Electrical Engineering at UNL. Her research interests include energy efficiency, renewable energy, numerical analysis and computer aided design of electric machinery and power electronics devices, dynamics and control of electric machinery, permanent magnet machines, and magnetic materials.